

Sri Lanka
Art. Nr. 443892
1/10

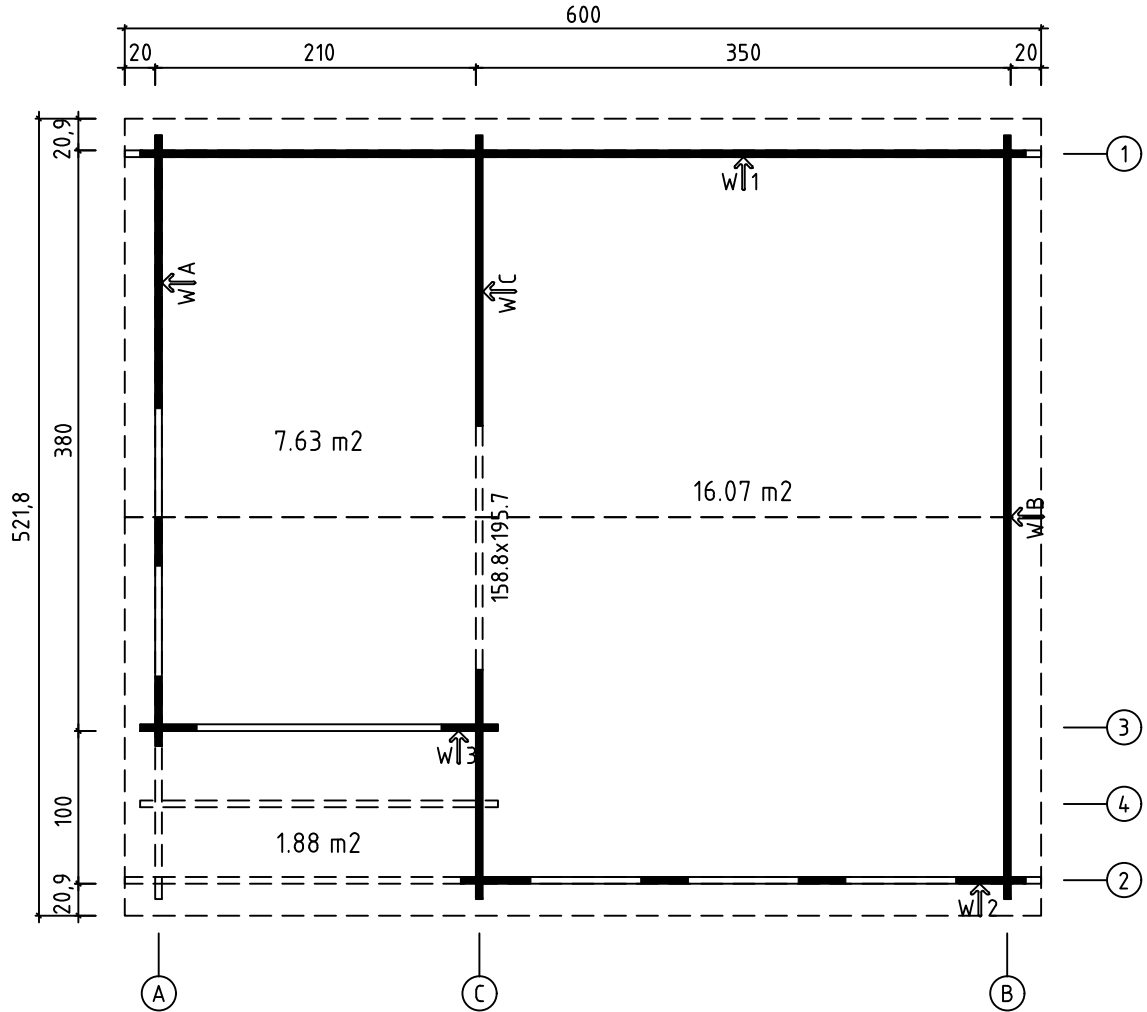

1.10.2019

Art. Nr. 443892
 Groundplan - Grundplan - Plan de masse - Planimetria - Plattegrond -
 Põhiplaan



Foundation - Fundament - Fondation - Fundamenta - Fundering - Immutatud
 alusraam

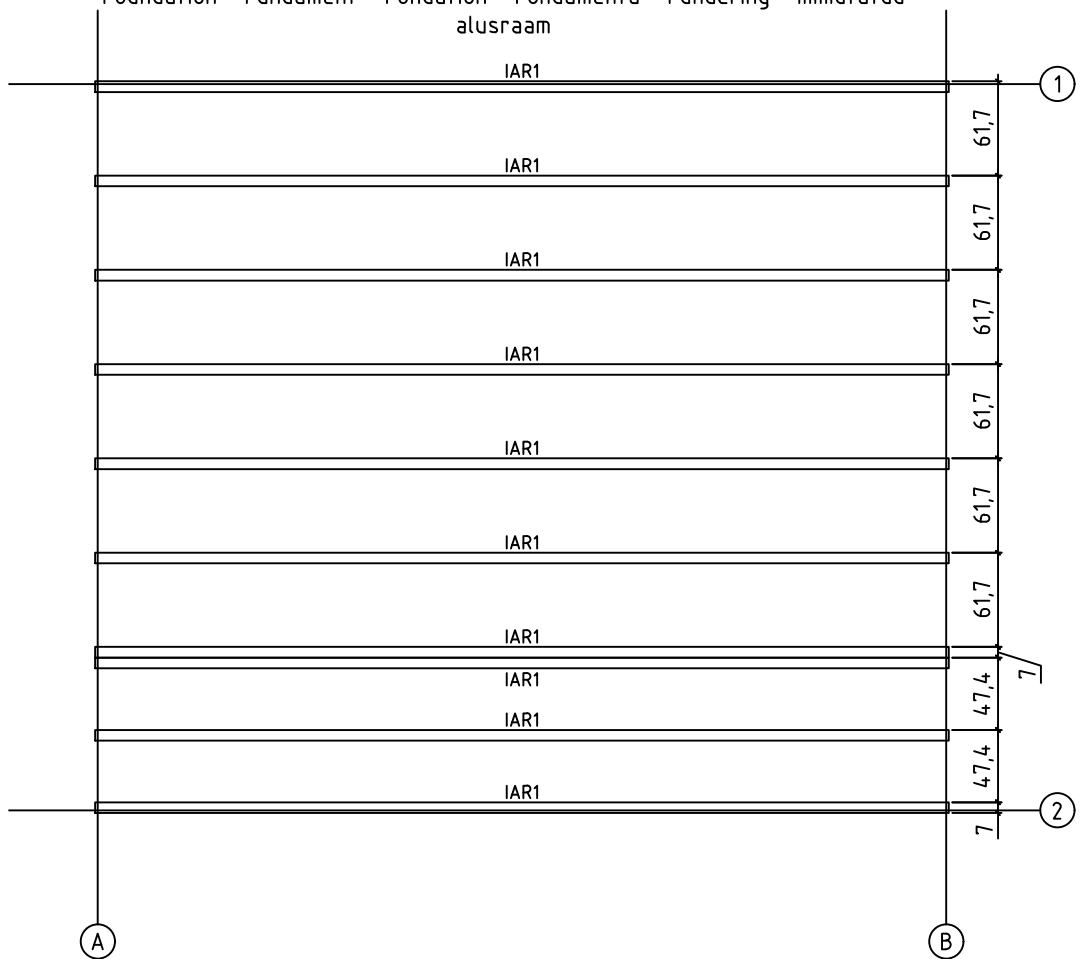

Floor boards - Fussbodenbretter - Lame de plancher - Pavimento - Vloerhout - Põrandalaud
Terrace boards - Terrassenbretter - Plancher de terrasse - Piattaforme terrazzo - Terrasvloer - Terrasilaudis

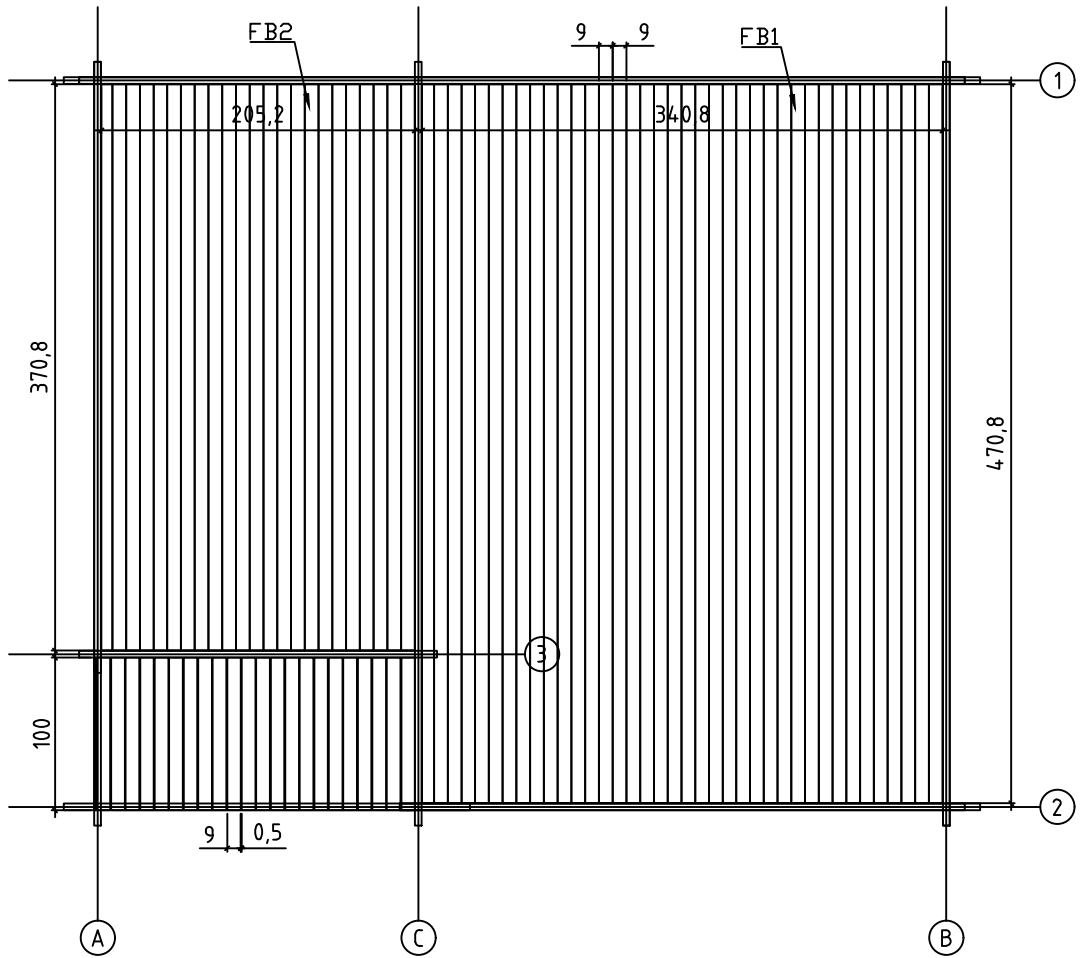

Ceiling boards - Deckenbrett - Voliges sous plafond - Tavole per piano soffitto - Dakhout - Laelaud

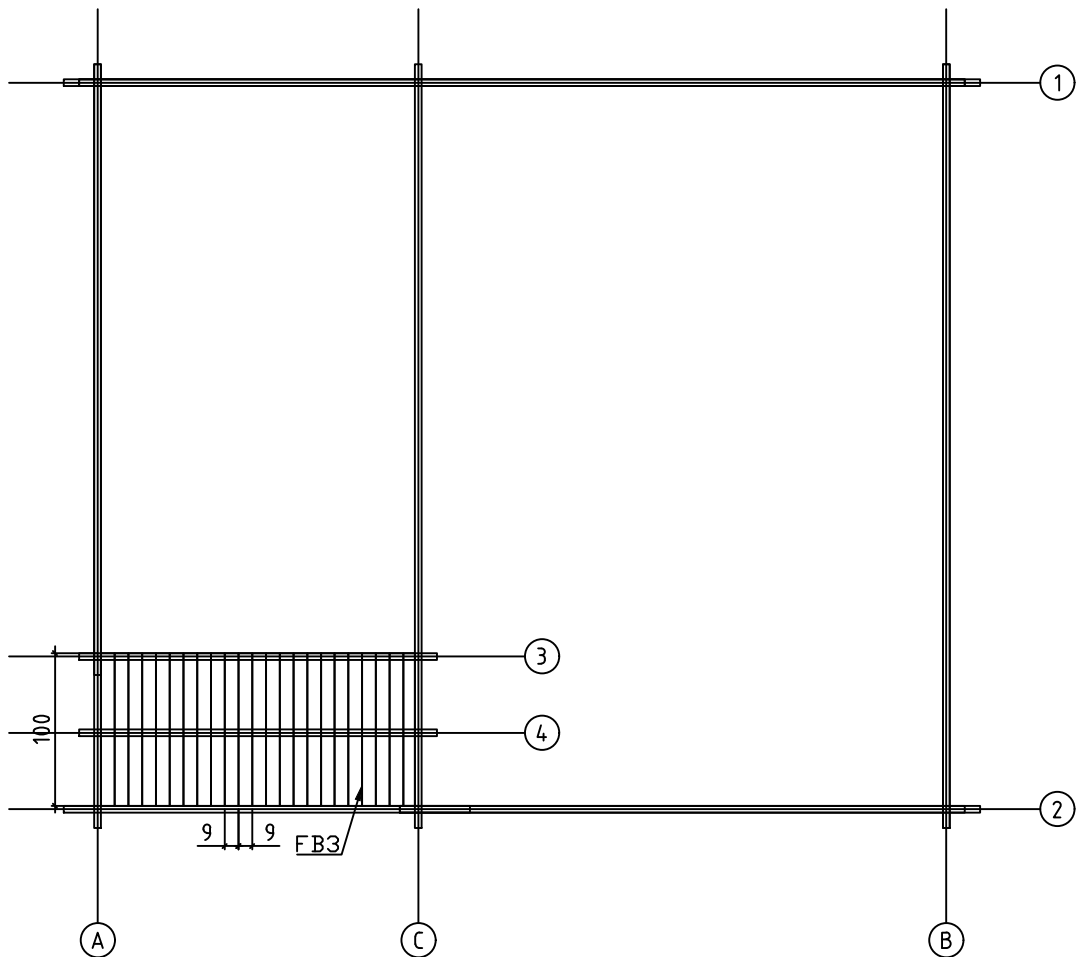

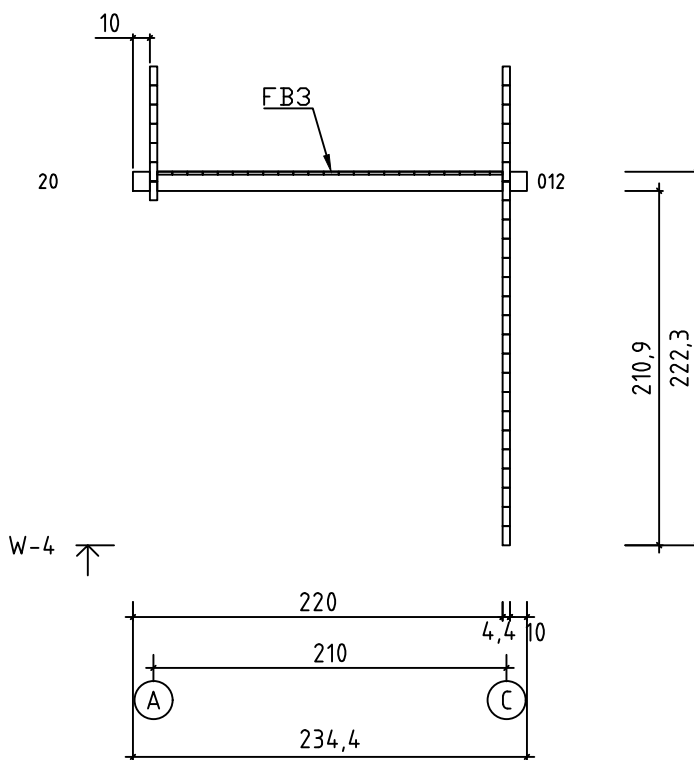
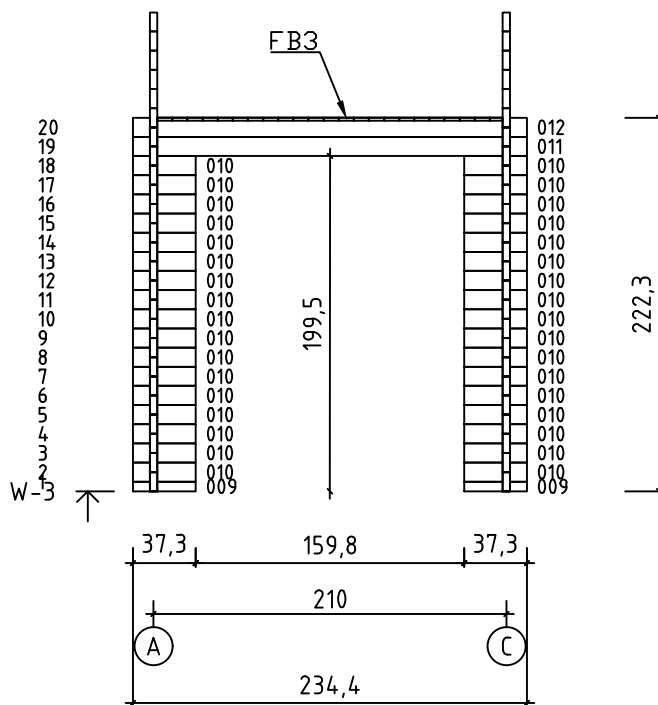

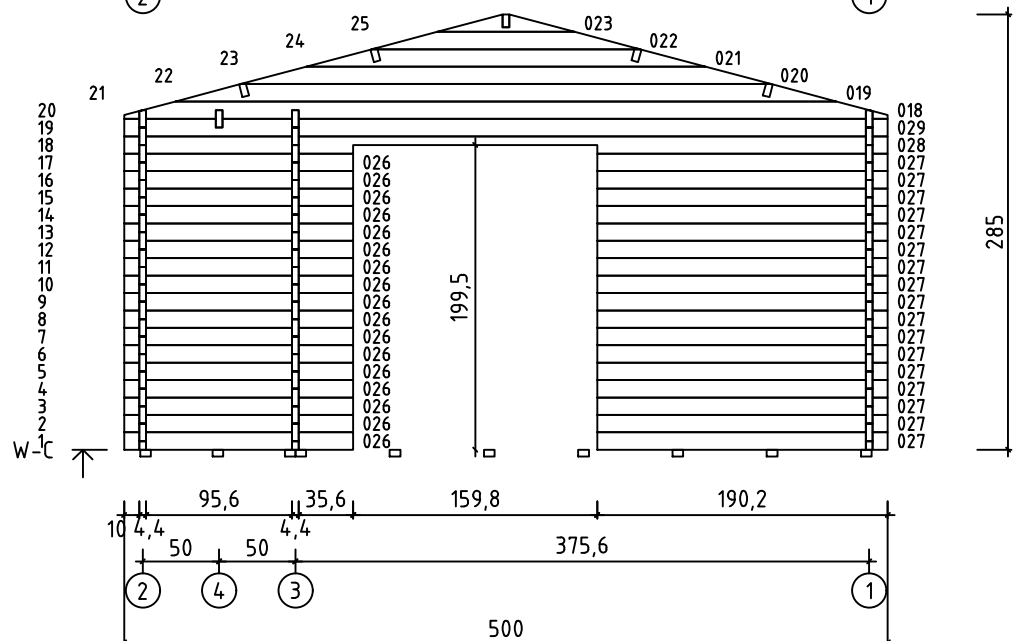
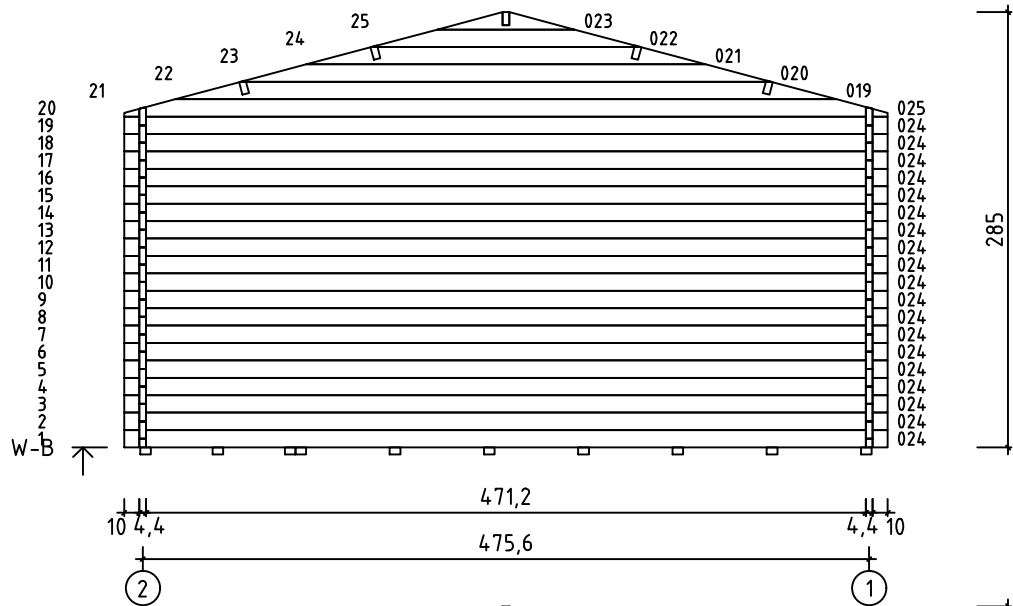
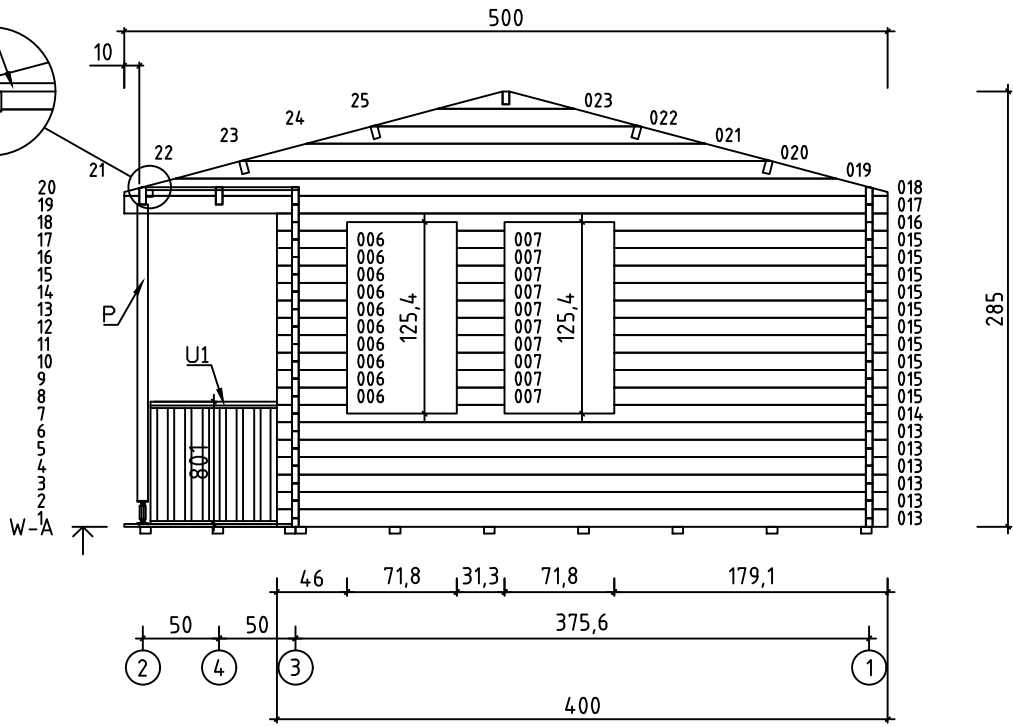
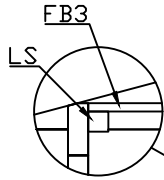









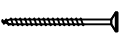

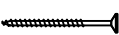





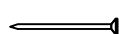

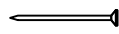
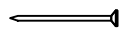

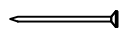
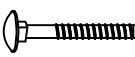
Pos	01.10.2019 Piece list - Stückliste - Liste des pièces - Elementi - Stuklijst - Tükítabel Art. Nr. 443892 7/10	Q	P (mm)	L (mm)
001		1	44x57	5800
002		18	44x114	5800
003		1	44x120	6000
004		1	44x57	3700
005		7	44x114	3700
006		32	44x114	460
007		32	44x114	313
008		1	44x120	6000
009		2	44x57	373
010		34	44x114	373
011		1	44x114	2344
012		2	44x114	2344
013		6	44x114	4000
014		1	44x114	4000
015		10	44x114	1791
016		1	44x114	4000
017		1	44x114	5000
024		19	44x114	5000
026		17	44x114	1500
027		17	44x114	1902
028		1	44x114	5000
029		1	44x114	5000
KFS-1	Storm protection - Sturmleiste - Latte anti-tempete - Protezione anti vento - Stormverankering / beveiliging - Tormikinnitusliist	4	22x45	2500

Pos	01.10.2019 Piece list - Stückliste - Liste des pièces - Elementi - Stuklijst - Tükitalabel Art. Nr. 443892 8/10	Q	P (mm)	L (mm)
WA-1 WC-1		1 1		
WB-1		1		
IAR1	Foundation - Fundament - Fondation - Fondamenta - Fundering - Immutatud alusraam 	10	70x45	5590
A-PR1	Roof beam - Dachbalken - Panne de toit - Perlina del tetto - Gordingen / dakbalk - Pärilin 	5	44x140	6000
FB1	Floor boards - Fussbodenbretter - Lame de plancher - Pavimento - Vloerhout - Põrandalaud	38	90x18	4708
FB2	Floor boards - Fussbodenbretter - Lame de plancher - Pavimento - Vloerhout - Põrandalaud	23	90x18	3708
FB3	Ceiling boards - Deckenbrett - Voliges sous plafond - Tavole per piano soffitto - Dakhout - Laelaud	23	90x18	1000
	Terrace boards - Terrassenbretter - Plancher de terrasse - Piattaforme terrazzo - Terrasvloer - Terrassilaud	23	90x19	1000
	Roof boards - Dachbretter - Voliges - Perlina per tetto - Dakhout - Katuselaud	134	90x18	2700
	Floor fillet - Fussbodenleiste - Corniere de finition du plancher - Finitura per pavimento (battisco pa) - Vloerafwerkljst - Põrandaliist		18x18	27.75
	Roofing felt fillet - Dachpappenleiste - Baguette de fixation du feutre bitumeux - Asse per fissaggio guaina bituminosa - Afdekljst asfaltpapier - Katusepapiilist	4	18x58	2750
P	Post - Pfosten - Poteau - Piede registrabile - Stijl - Post	1	70x70	1940
	Terrace railing - Terrassenzaun - Garde-corps de terrasse - Ringhiera per terrazza - Terras rails (leuning) - Piirdeaed kõrgusega 	1	303x44	830
TB-1	Fascia board - Traufbrett - Bandeau de toit - Finitura lati tetto - Gevelljst - Räästalaud	4	18x90	3000
DRV-1	Roof edge reinforcement - Dachrandverstärkung - Corniere de renfort de bord de toit - Rinforzo x tetto - Dakrand versterking - Räästatugevdus	4	28x34	3000
U1	U-profile - U-profils - Profile u - Profilo ad u - U-profiel - U-profiil	1	35x70	830
LS	Loft support - Dachbefestigung - Cornière de renfort de fixation de toiture - Supporto dello schienale - Dakbevestiging - Vahelae kandurliist	1	44x44	2055
	Gable moulding - Giebelleiste - Planche de rive - Finitura per frontale e retro del tetto - Gevelljst - Viilulaud	4	18x120	2750

Pos	01.10.2019 Piece list - Stückliste - Liste des pièces - Elementi - Stuklijst - Tükítabel Art. Nr. 443892 9/10	Q	P (mm)	L (mm)
HS8	Screw for gable segment - Schrauben für deckblatt - Vis pour fixation losange de finition - Viti x frontali tetto - Schroef voor gevelpunt segment - Kruvi rombile 	4	3.5x35	
HS9	Screw for u-profile - Schraube zur befestigung u-profil - Vis a tete fraisée pour profil u - Vite per profilo ad u - Schroef ter bevestiging u-profiel - Kruvi U-profiilite 	4	3.5x50	
HS9	Screw for gable moulding - Schrauben für giebelleiste - Vis pour fixation planche de rive - Vite per fissare finiture davanti e dietro del tetto - Schroef voor gevellijst - Kruvi viilulauale 	32	3.5x50	
HS14	Screw for u-profile - Schraube zur befestigung u-profil - Vis a tete fraisée pour profil u - Vite per profilo ad u - Schroef ter bevestiging u-profiel - Kruvi U-profiilite 	12	4.5x80	
HS14	Screw for fixing terrace railing - Schraube für terrasse - Vis de fixation de garde-corps de terrasse - Vite per fissaggio della ringhiera al terrazzo - Schroef voor terras - Kruvi piirdeaia kinnituseks 	6	4.5x80	
HS14	Screw for loft support - Schraube für dachbefestigung - Vis pour cornière de renfort de fixation - Viti per supporto del soppalco - Schroef voor dakbevestiging - Kruvi vahelae kandurliistule 	6	4.5x80	
HS12	Screw for fascia boards - Schrauben für traufbretter - Vis pour fixation bandeau de toit - Viti x striscia del tetto - Schroef voor gevellijst - Kruvi räästalauale 	28	4x40	
HS12	Screw for roof edge reinforcement - Schrauben für dachrandverstärkung - Vis pour fixation corniere renfort de bord de toit - Viti x rinforzo bordo tetto - Schroef voor dakrand versterking - Kruvi räästatugevdusele 	28	4x40	
HS13	Screw for post - Schrauben für pfosten - Vis de fixation des poteaux - Viti per inviare - Schroef voor stijlen - Kruvi postile 	2	4x60	
HS18	Screw for foundation - Schrauben zur befestigung fundament - Vis de fixations des poutrelles de fondations - Viti x fondamenta - Schroef voor fundering - Kruvi alusraamile 	4	5x120	
HS18	Screw for roof beams - Schrauben für dachbalken - Vis pour fixation pannes de toit - Viti per perline del tetto - Schroef voor gordingen / dakbalken - Kruvi pärlinitele 	21	5x120	
HS18	Screw for gable - Schrauben für giebel - Vis pour fixation des pignons - Viti per timpano - Schroef voor gevelpunt - Kruvi viilude kinnitamiseks 	36	5x120	
HS16	Screw for 1. wall beam - Schraube für 1. bohlenreihe - Vis de fixations 1ere rangée de madriers avec poutrelles de fondations - Vite fissaggio alle fondamenta - Schroef voor 1 wandbalk - Kruvi poollauale 	11	5x90	
HS20	Screw for post height adjustment - Schrauben für regulierungsschraube für pfosten - Vis de fixation de support réglable de poteau - Viti per fissare ed aggiustare l'altezza del palo verticale - Schroef voor hoogte instelling stijlen - Kruvi vajumisplidile 	8	6x50	
NF2	Zn nail for floor fillet - Zn nagel für fussbodenleiste - Pointe pour corniere de finition du plancher - Chiodi x fissaggio pavimento - Spijker(nagel) voor vloer afdeklijst - Nael põrandaliistule 	58	1.4x40	
SH44	Hammer block - Schlagholz - Calle de frappe - Blocco di legno da usare come cuscinetto quando si usa il martello - Slagklos - Löögiklots 	1		
SFS	Nut for storm protection - Schraubenmutter für sturmleiste - Erou pour latte anti-tempete - Dado x asta protezione vento - Moer voor stormverankering - Mutter tormikinnitusliistule 	8	D8	
NF3	Zn nail for terrace - Zn nagel für terrassenbretter - Pointe pour plancher de terrasse - Chiodo zincato per terrazza - Spijker(nagel) voor terrasvloer - Nael terrasilauale 	138	2.1x50	
NF4	Zn nail for roof - Zn nagel für dachbretter - Pointe pour fixation voliges de toit - Chiodi x perline tetto - Spijker(nagel) voor dakhout - Nael katuselauale 	562	2x50	
NF4	Zn nail for floor - Zn nagel für fussbodenbretter - Clous pour plancher - Chiodi x perline pavimento - Spijker(nagel) voor vloer - Nael põrandalauale 	591	2x50	
NF5	Zn nail for roofing felt fillet - Zn nagel für dachpappenleiste - Pointe pour baguette de fixation feutre bitumeux - Chiodi x carta bituminosa x tetto - Spijker(nagel) voor asfaltpapier afdeklijst - Papiliistunael 	28	2x40	
BFS	Bolt for storm protection - Bolzen für sturmleiste - Boulon pour latte anti-tempete - Bullone x asta protezione vento - Bout voor stormankertlat - Puidupolt tormikinnitusliistule 	8	8x80	
GS	Gable segment - Deckblatt - Losange de finition - Decorazione in legno x frontale tetto - Gevelpunt segment - Romb 	2		

Pos	01.10.2019 Piece list - Stückliste - Liste des pièces - Elementi - Stuklijst - Tükítabel Art. Nr. 443892	10/10	Q	P (mm)	L (mm)
DFS	Washer for storm protection - Dichtscheibe für Sturmleiste - Rondelle pour latte anti-tempete - Rondella x asta protezione vento - Afdichtring voor storm strip - Seib tormikinnitusliistule		8	D8	
	Post height adjustment - Pfostenträger verstellbar - Support réglable de poteau - Piede registrabile in altezza - Stelschroef voor stijlpost - Vajumispost		1	D20	
	Door frame - Türrahmen - Pour montant de porte - Telaio della porta - Deur kozijn - Ukseteng	1588x1957	1		

Doors and windows are not included. They can be bought extra as 9900600 - Sri lanka B / 9900700 Sri lanka A

Die fenster und türen gehören nicht zum lieferumfang und können separaat bestellt werden.

La porte et les fenêtres ne sont pas incluses avec l'abri. Elles sont disponibles en option sous la référence 9900600 - Sri lanka B / 9900700 Sri lanka A

Porte e finestre non sono incluse. Possono essere aggiunti per extra come 9900600 - Sri lanka B / 9900700 Sri lanka A

Deuren en Ramen worden niet geleverd in dit pakket, u kan deze apart bestellen met art 9900600 - Sri lanka B / 9900700 - Sri lanka A

Uks ja aknad pole maja komplektis. Neid saab soetada eraldi lisapakina 9900600 - Sri lanka B / 9900700 Sri lanka A