

Art. No. 289650

1/6



28x114mm

30.09.2011



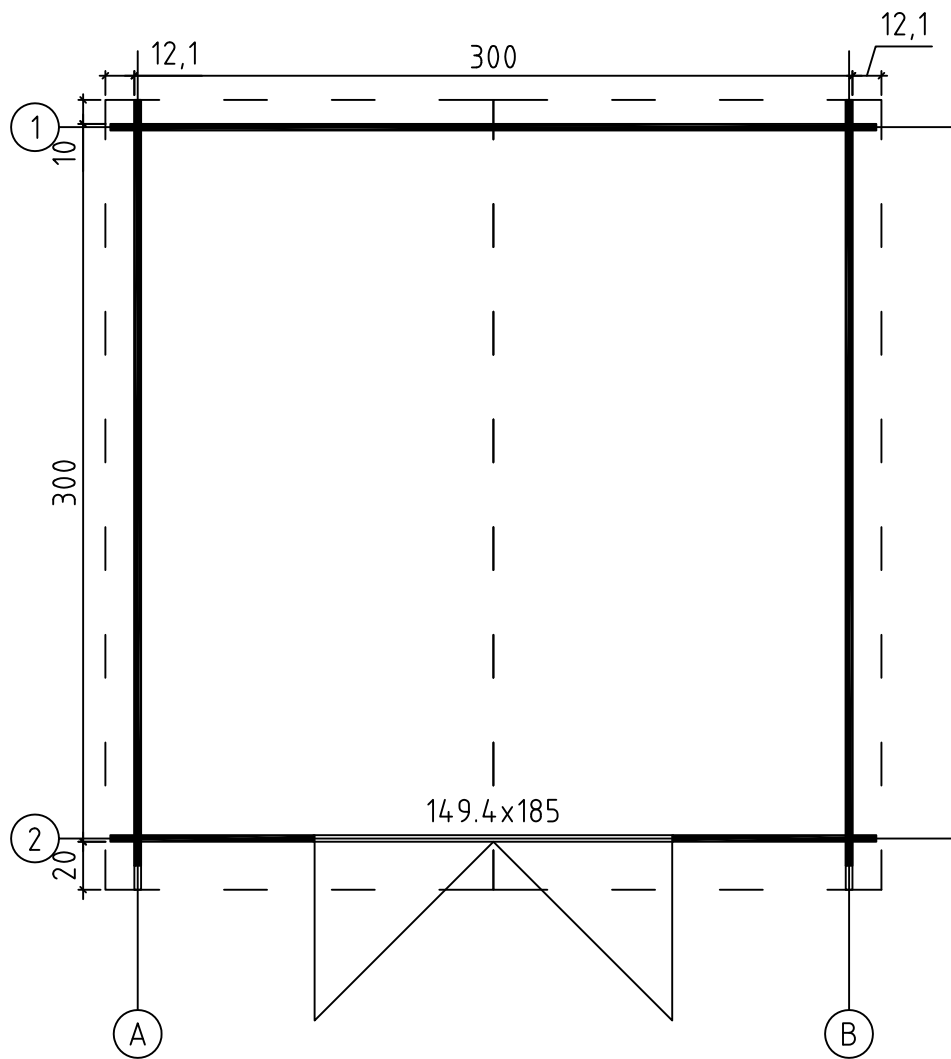

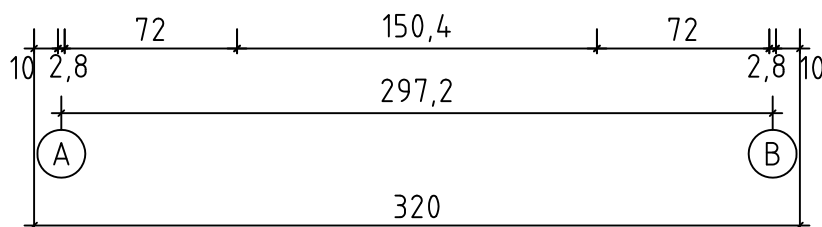
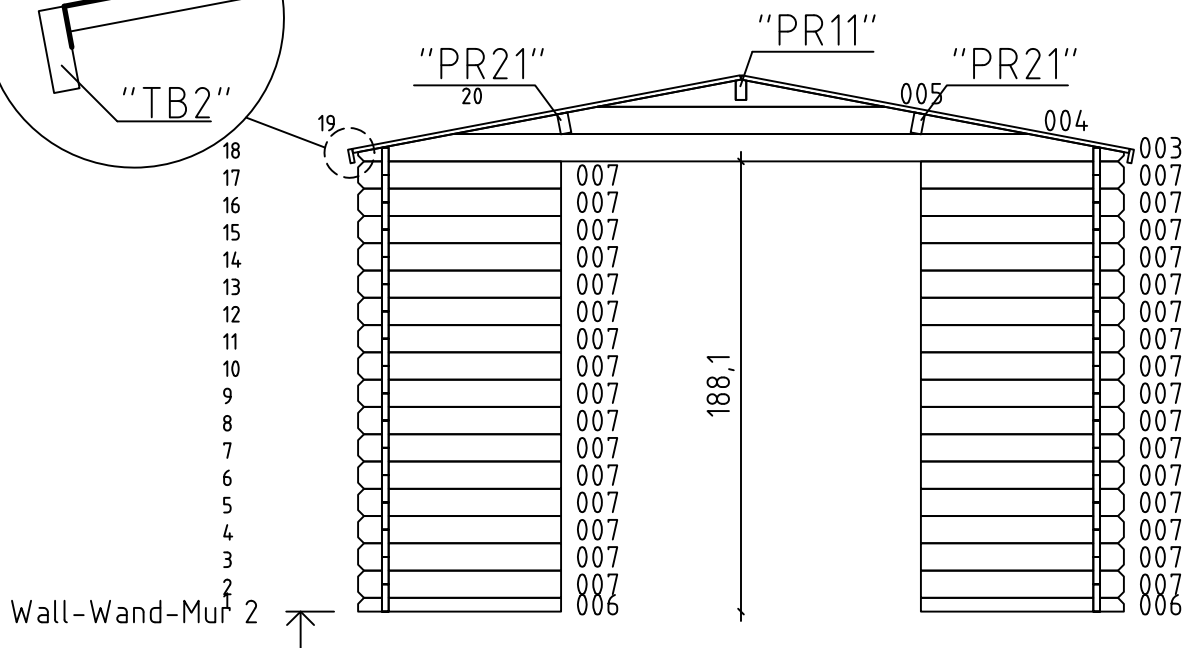
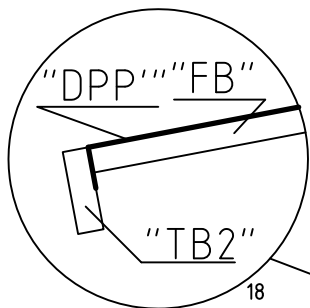
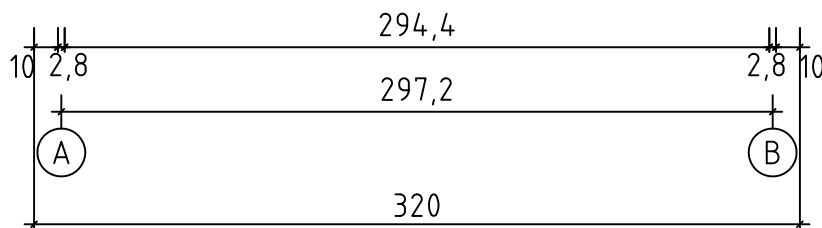
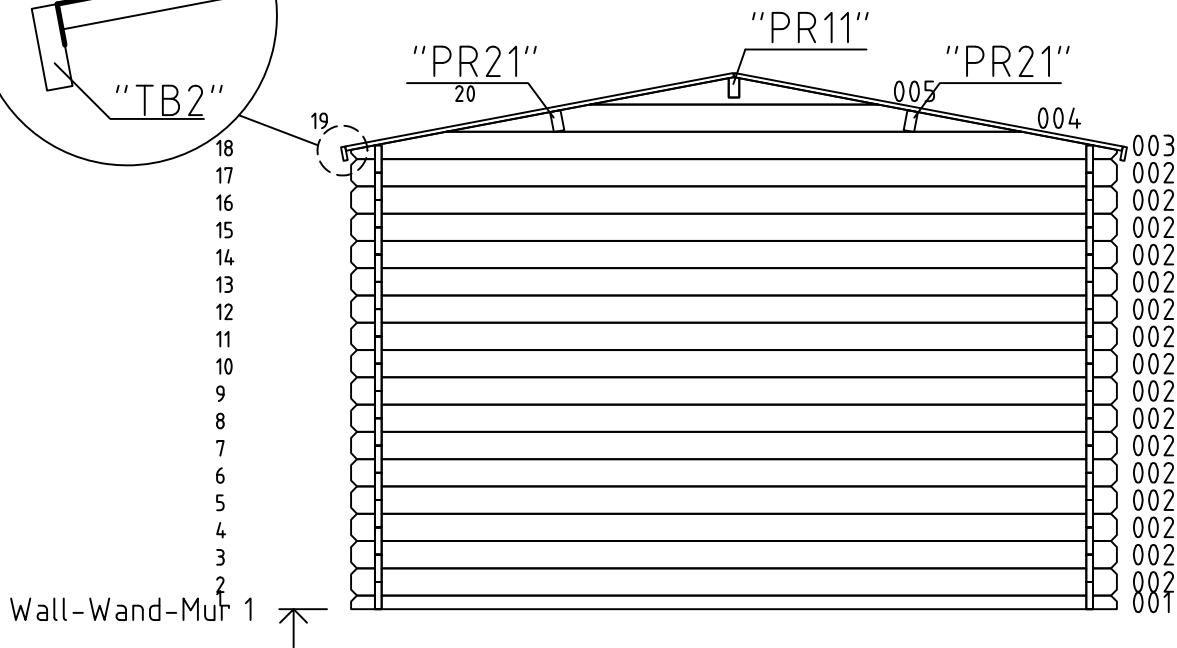
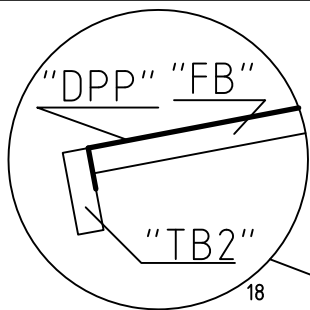

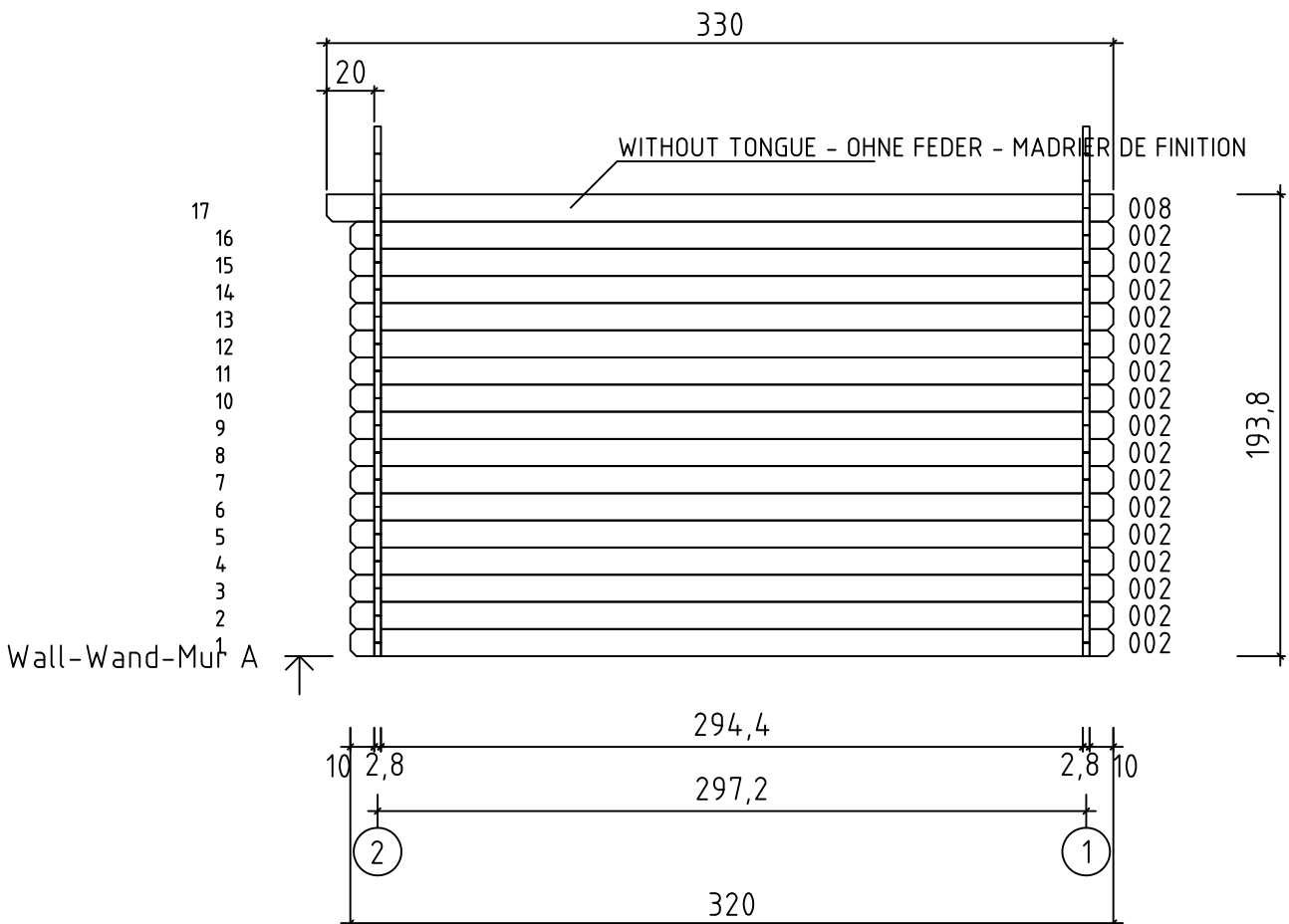
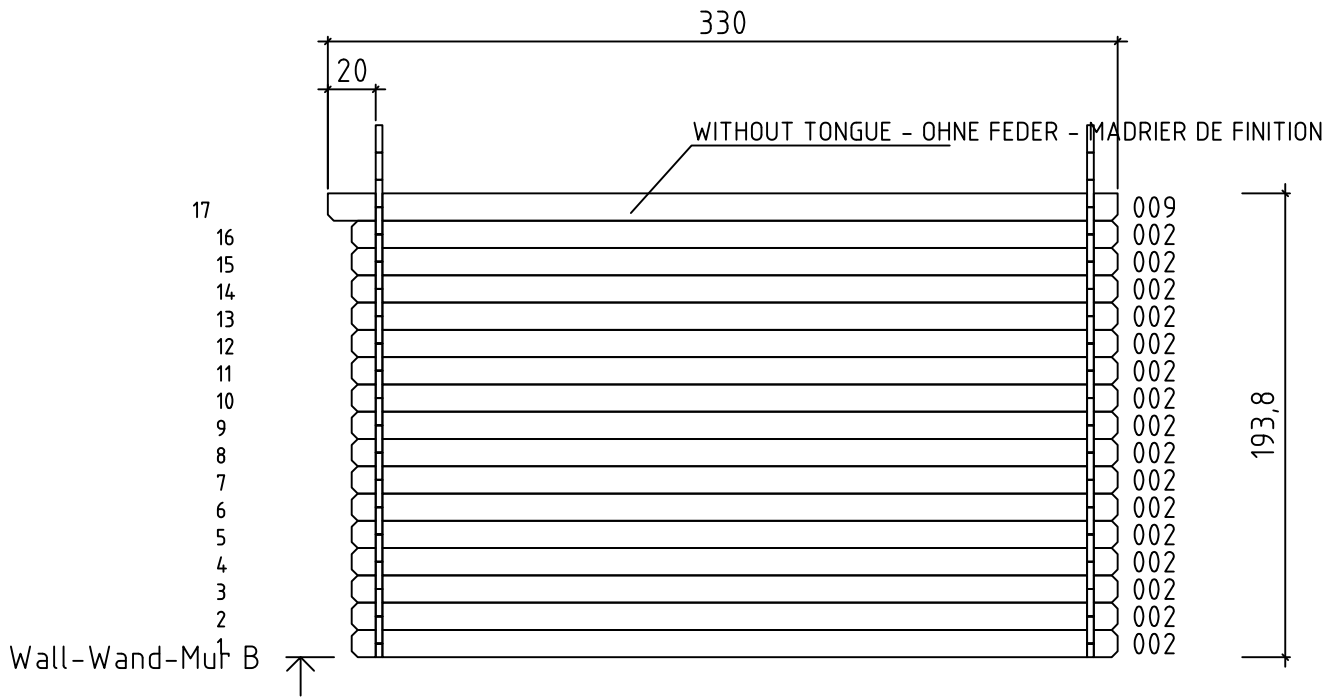



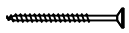

GROUNDPLAN - GRUNDPLAN - PLAN DE MASSE

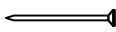
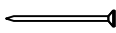

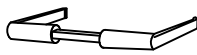

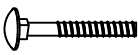

Pos	30.09.2011	ART.NR. 289650	5/6	Q.	P (mm)	L (mm)
001				1	28x57	3200
002				48	28x114	3200
006				2	28x57	848
007				32	28x114	848
008				1	28x114	3300
009				1	28x114	3300
W1-1				1		
W2-1				1		
PR11	 ROOF BEAM - DACHBALKEN - PANNE DE TOIT			1	44x120	3300
PR21	 ROOF BEAM - DACHBALKEN - PANNE DE TOIT			2	44x120	3300
DB	ROOF BOARDS - DACHBRETTER - VOLIGES			74	90x18	1650
DPL	ROOFING FELT FILLET - DACHPAPPENLEISTE - BAGUETTE DE FIXATION DU FEUTRE BITUMEUX			4	18x58	1700
DPL	ROOFING FELT FILLET - DACHPAPPENLEISTE - BAGUETTE DE FIXATION DU FEUTRE BITUMEUX			2	18x58	3300
DPP	ROOFING FELT - DACHPAPPE - FEUTRE BITUMEUX			4		3400
KFS	STORM PROTECTION - STURMLEISTE LATTE ANTI-TEMPETE			4	22x45	1900
GL	GABLE MOULDING - GIEBELLEISTE PLANCHE DE RIVE			4	18x120	1700
HS1	SCREW FOR DOOR LOCK - SCHRAUBEN FÜR TÜRSCHLOSS - VIS POUR SERRURE DE PORTE			2	2.5x25	
HS12	SCREW FOR GABLE SEGMENT - SCHRAUBEN FÜR DECKBLATT - VIS POUR FIXATION LOSANGE DE FINITION			4	3.5x35	
HS22	SCREW FOR FIXING DOOR TO THE WALL - SCHRAUBE ZUR BEFESTIGUNG TÜR- ZARGE MIT WAND - VIS DE FIXATION DORMANT DE PORTE			2	3.5x50	
HS16	SCREW FOR GABLE MOULDING - SCHRAUBEN FÜR GIEBELLEISTE - VIS DE FIXATION POUR PLANCHE DE RIVE			24	3.5x50	
HS3	SCREW FOR DOOR FILLET - SCHRAUBE ZUR BEFESTIGUNG TÜRLEISTE VIS D'ASSEMBLAGE DU CADRE DE PORTE			5	3x30	
HS59	SCREW FOR DOORSTEP - SCHRAUBEN FÜR SWELLE - VIS DE FIXATION DU SEUIL DE PORTE			3	3x30	
HS56	SCREW FOR FIXING BOLT HINGE - SCHRAUBE FÜR TÜRRIGEL - VIS DE FIXATION POUR CHARNIERES ET GONDS DE PORTE			16	4.5x25	
HS58	SCREW FOR FIXING BOLT HINGE - SCHRAUBE FÜR TÜRRIGEL - VIS DE FIXATION POUR CHARNIERES ET GONDS DE PORTE			12	4.5x35	
HS32	SCREW FOR EAVES BOARDS - SCHRAUBEN FÜR TRAUFBRETTER - VIS DE FIXATION POUR BANDEAU DE TOIT			14	4x40	

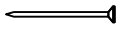
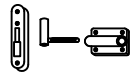
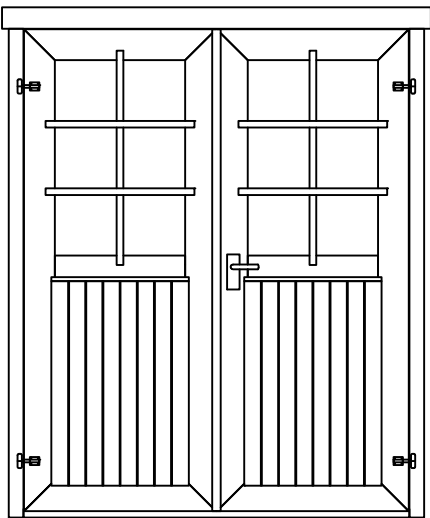
Pos	30.09.2011	ART.NR. 289650	6/6	Q.	P (mm)	L (mm)
HS77	SCREW FOR DOOR JAMB - SCHRAUBE FÜR TÜRRAHMEN - VIS DE FIXATION POUR MONTANT DE PORTE			2	4x60	
HS43	SCREW FOR ROOF BEAMS - SCHRAUBEN FÜR DACHBALKEN - VIS POUR PANNE DE TOIT			10	5x120	
HS41	SCREW FOR DOOR JAMB - SCHRAUBE FÜR TÜRRAHMEN - VIS DE FIXATION POUR MONTANT DE PORTE			2	5x90	
TL3	STICKER FOR LOCK -SCHLIEßBLECH FÜR TÜRSCHLOSS -GACHE DE PORTE			1		
SH28	HAMMER BLOCK - SCHLAGHOLZ - CALLE DE FRAPPE			1		
NFD	ZN NAIL FOR ROOFING FELT FILLET - ZN NÄGEL FÜR DACHPAPPEN-LEISTE - POINTE POUR BAGUETTE FIXATION FEUTRE BITUMEUX			20	2x40	
NF	ROOFING NAILS FOR ROOFING FELT - NÄGEL FÜR DACHPAPPE - POINTE DE FIXATION POUR FEUTRE BITUMEUX			115	2.1x17	
TL1	DOOR LOCK - TÜRSCHLOSS -SERRURE DE PORTE			1		
TL4	DOOR HANDLE FITTINGS-TÜRGRIF - SET DE GARNITURES DE SERRURE DE PORTE			1		
TL5	DOOR LOCK COVER - SCHLOSSBLENDE - GARNITURE DE SERRURE DE PORTE			1		
TL	LATCH BOLT FÜR DOUBLE DOOR - TORRIEGEL - LOQUET POUR DOUBLE PORTE			2		
GS	GABLE SEGMENT-DECKBLATT - LOSANGE DE FINITION			2		
SFS	NUT FOR STORM PROTECTION - SCHRAUBENMUTTER FÜR STURMLEISTE - ÉCROU POUR LAME ANTI-TEMPETE			8		
BFS	BOLT FOR STORM PROTECTION - BOLZEN FÜR STURMLEISTE - VIS POUR LAME ANTI-TEMPETE			8		
DFS	WASHER FOR STORM PROTECTION - DICHTSCHEIBE FÜR STURMLEISTE - RONDELLE POUR LAME ANTI-TEMPETE			8		
NF2	ZN NAIL FOR ROOF - ZN NÄGEL FÜR DACHBRETTER - POINTE POUR TOIT			236	2.1x60	
TT	MALE BOLT HINGE FOR DOOR - TÜRRIEGEL - PARTIE MALE DE CHARNIERE DE PORTE			4		
	DOOR-TÜR-PORTE 14.94x1850	TUK.2.056.SVP.M28		1		
						

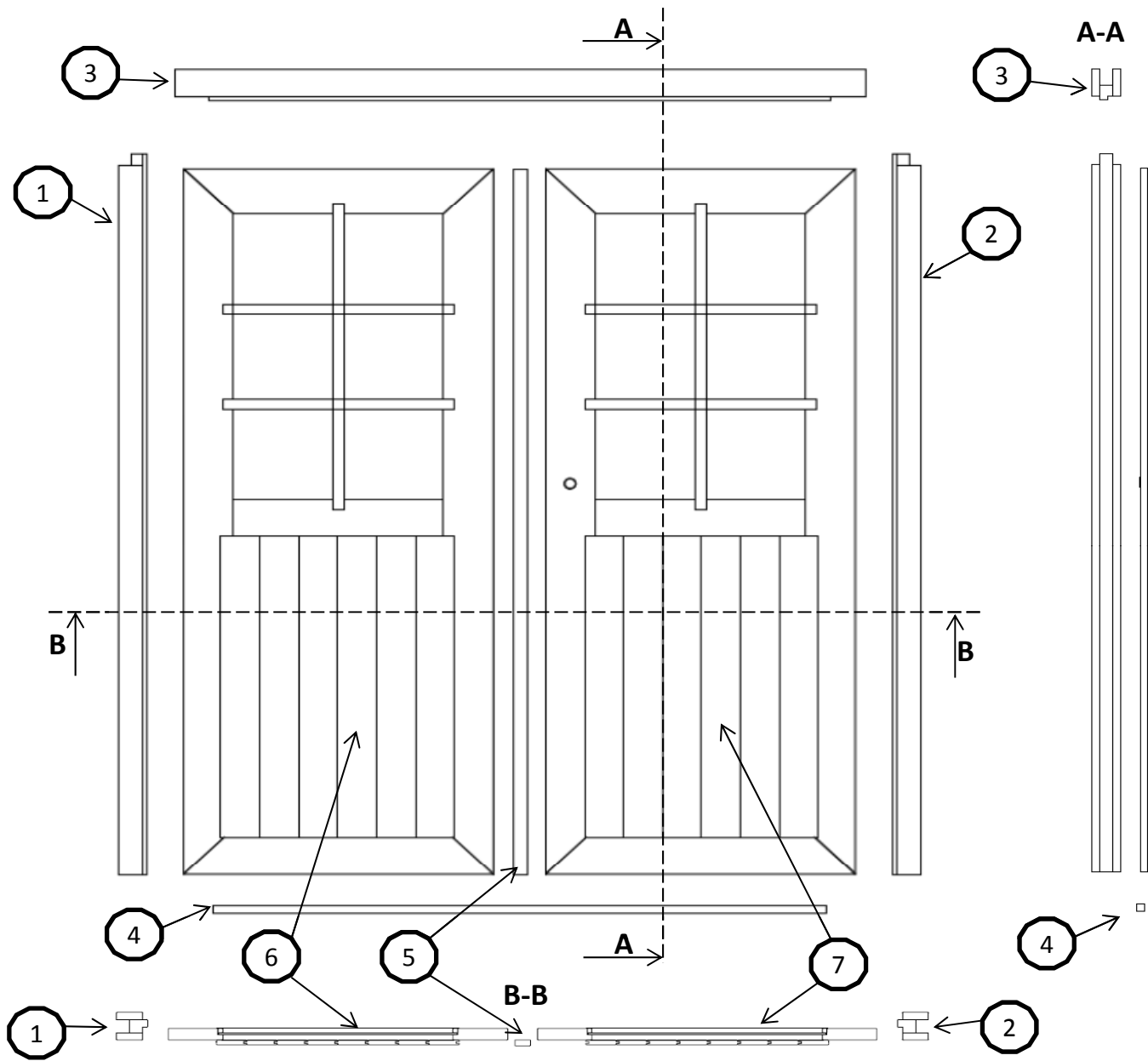

Pos.	Q.	Dimensions
1	1	65 mm, 66 mm
2	1	65 mm, 66 mm
3	1	65 mm, 66 mm
4	1	18 mm
5	1	18 mm, 31 mm
6	1	716 mm
7	1	716 mm

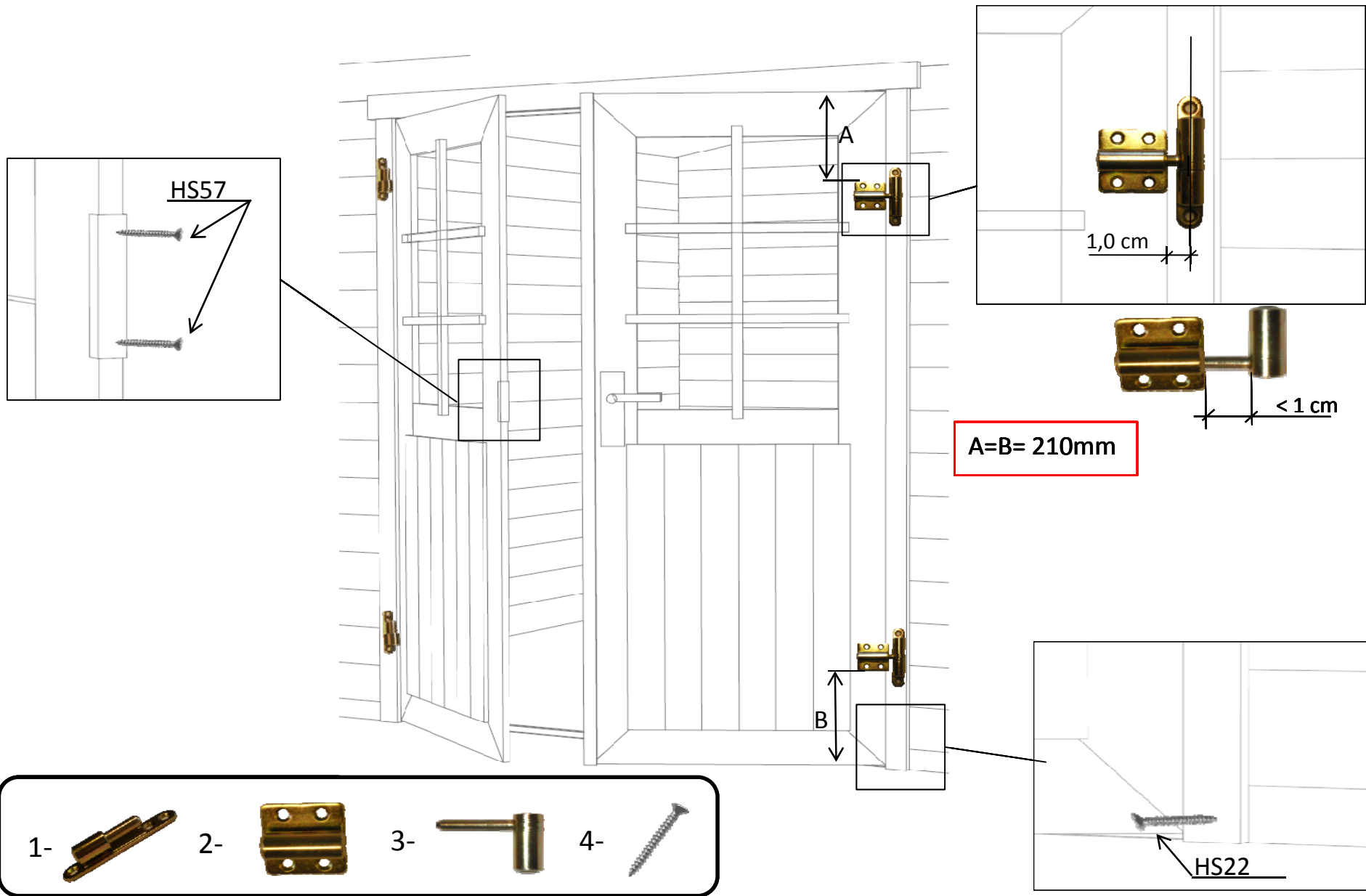

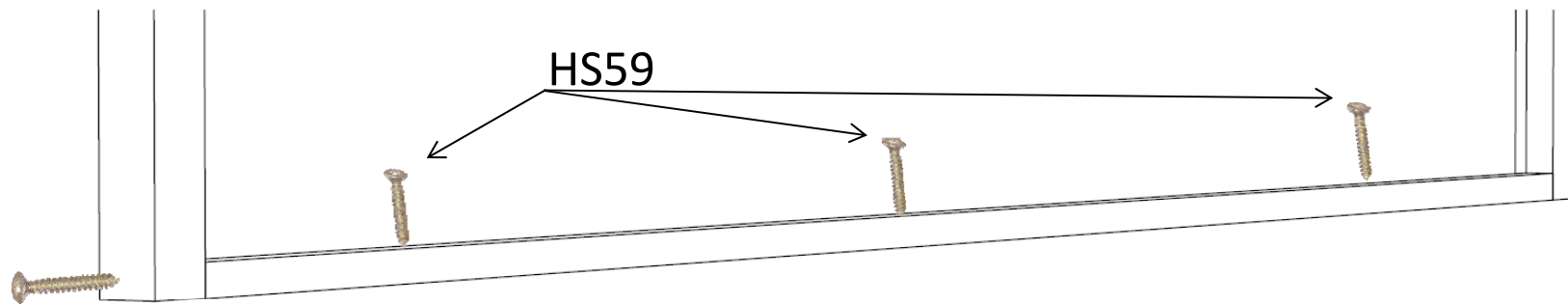

4,0x60mm

