

Java
Art. Nr. 4415711
1/12

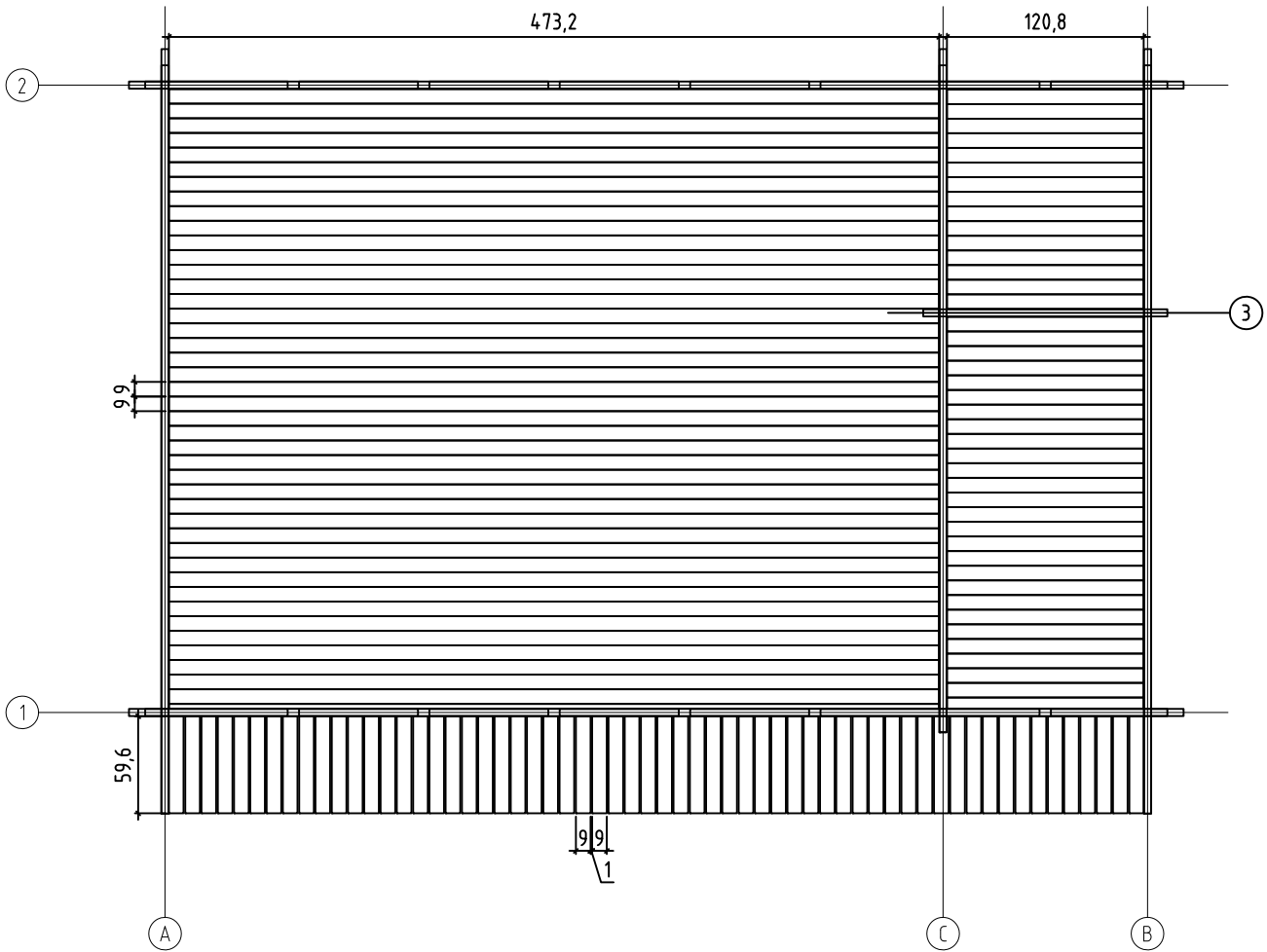

6.06.2014

FLOOR BOARDS - FUSSBODENBRETTER - LAME DE PLANCHER
TERRACE BOARDS - TERRASSENBRETTER - PLANCHER DE TERRASSE



ROOF PLAN - DACH-PLAN - PLAN DU TOIT

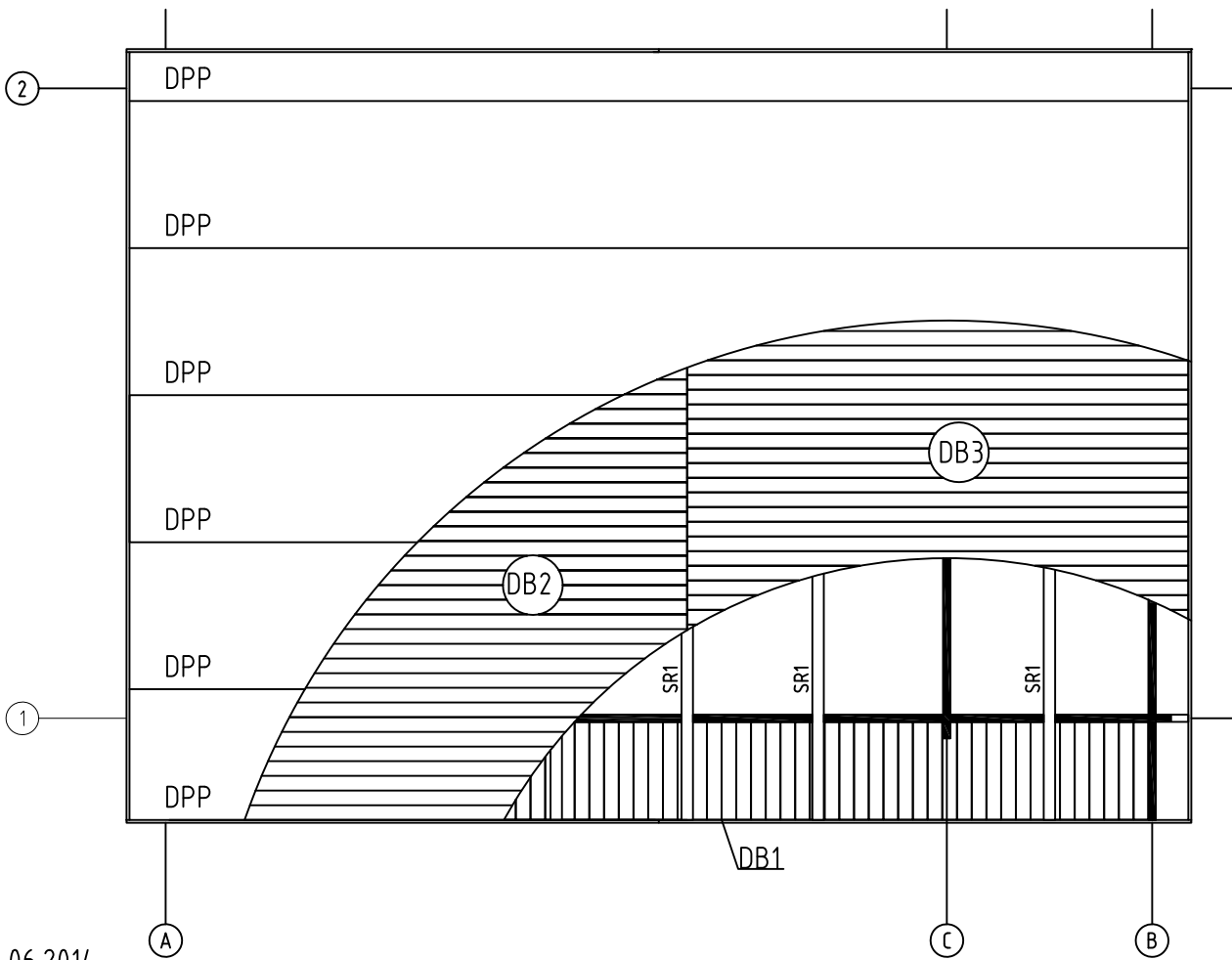

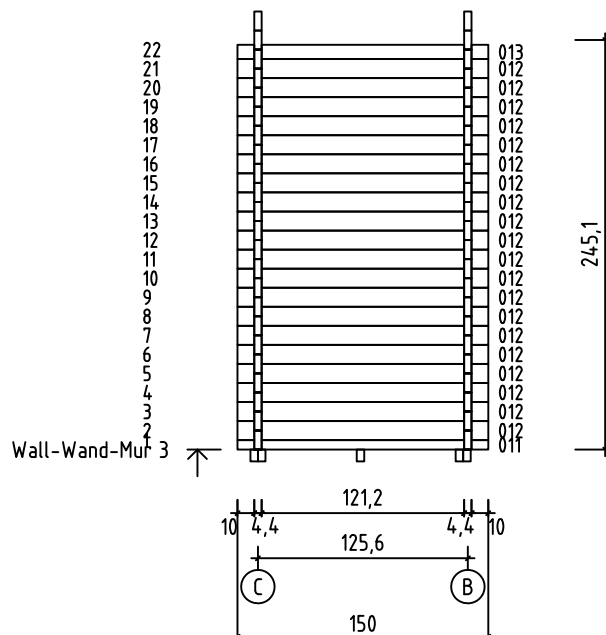
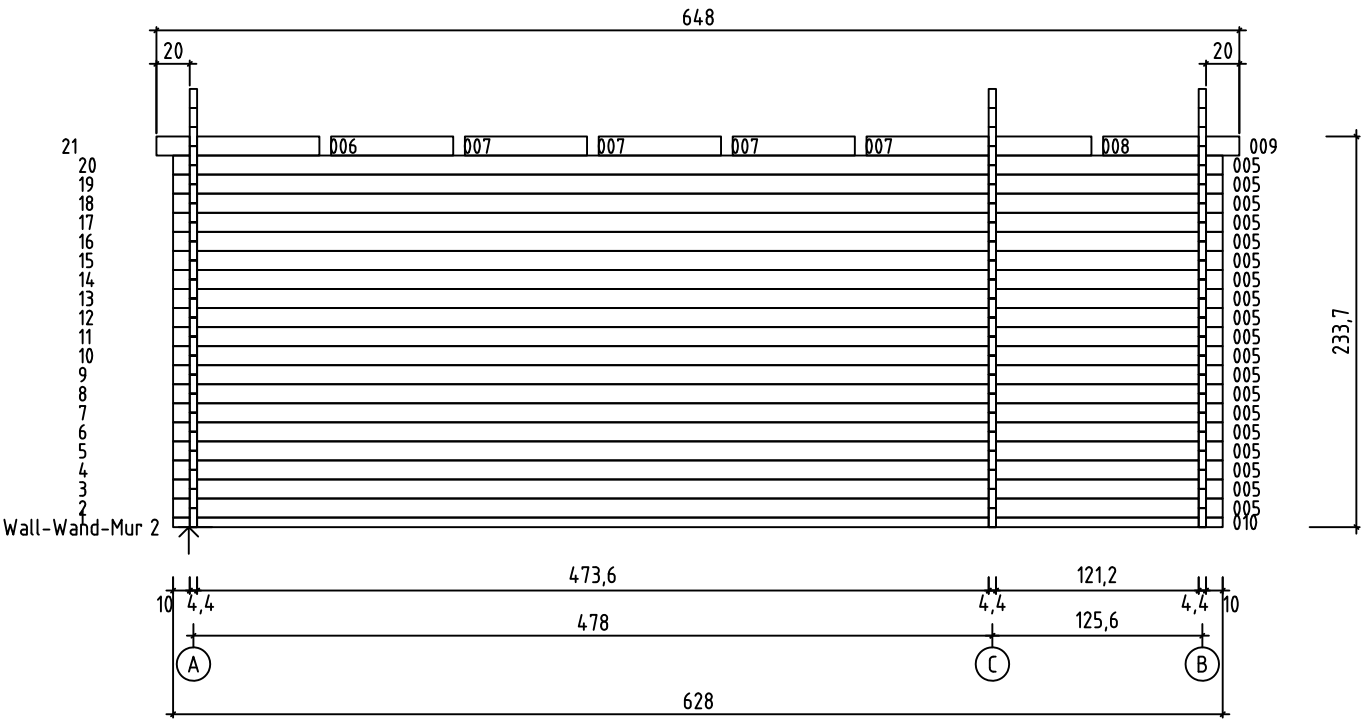
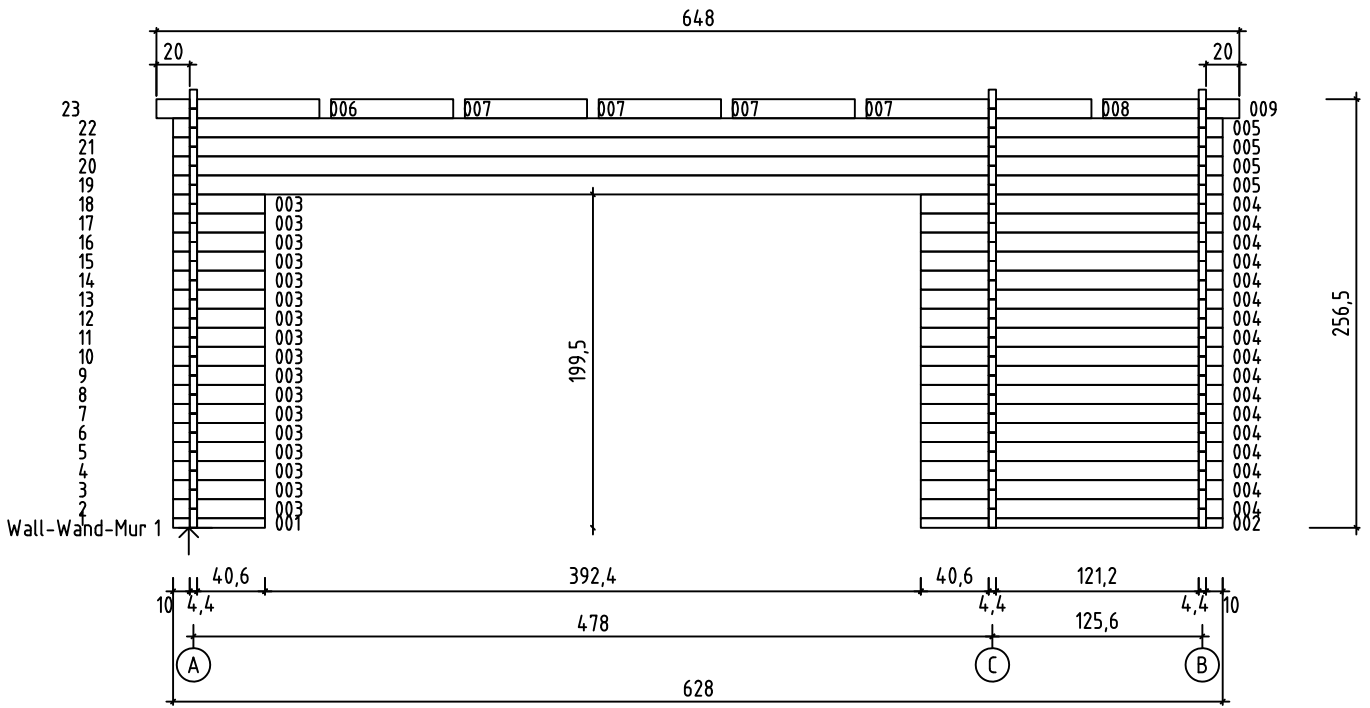

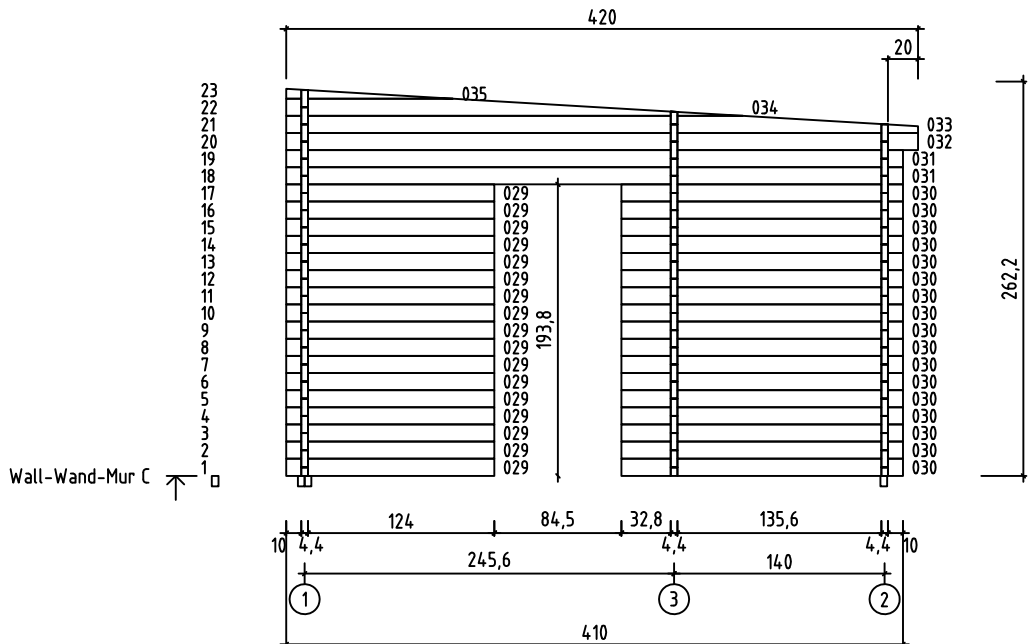
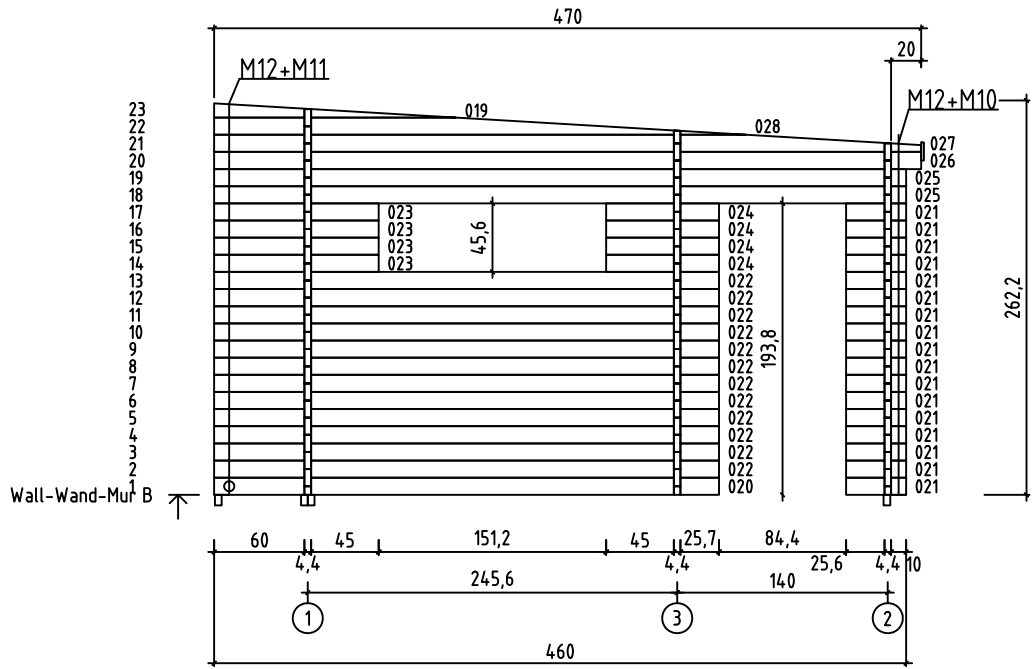
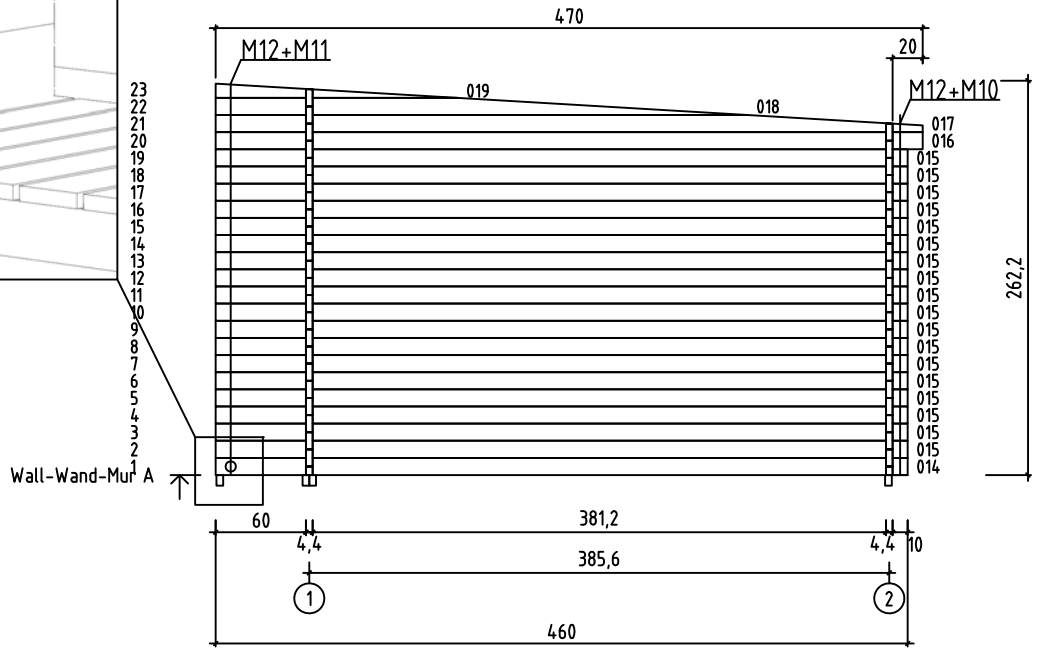
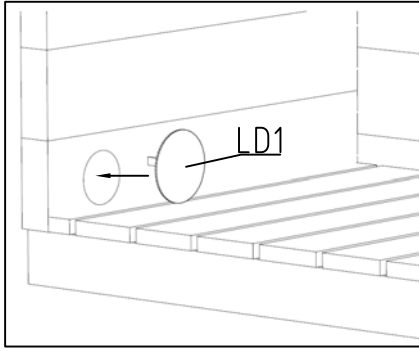

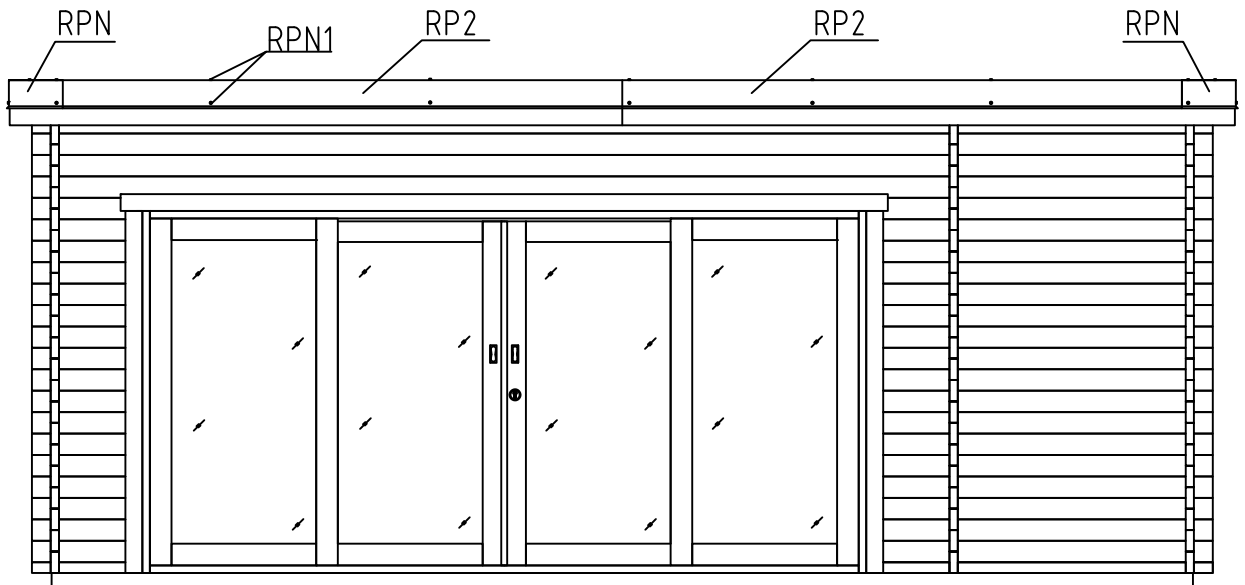

Wall-Wand-Mur 1 ↑

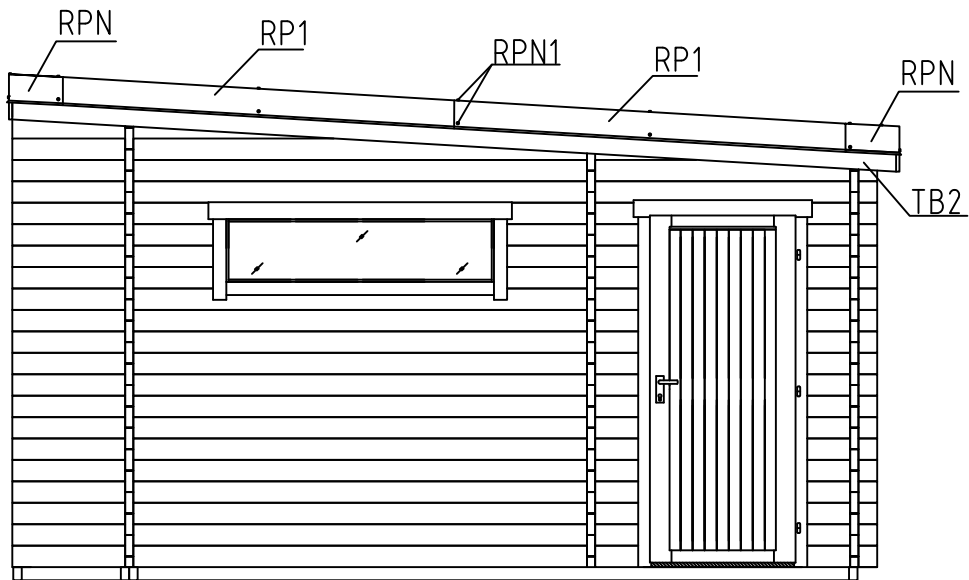





Wall-Wand-Mur B ↑

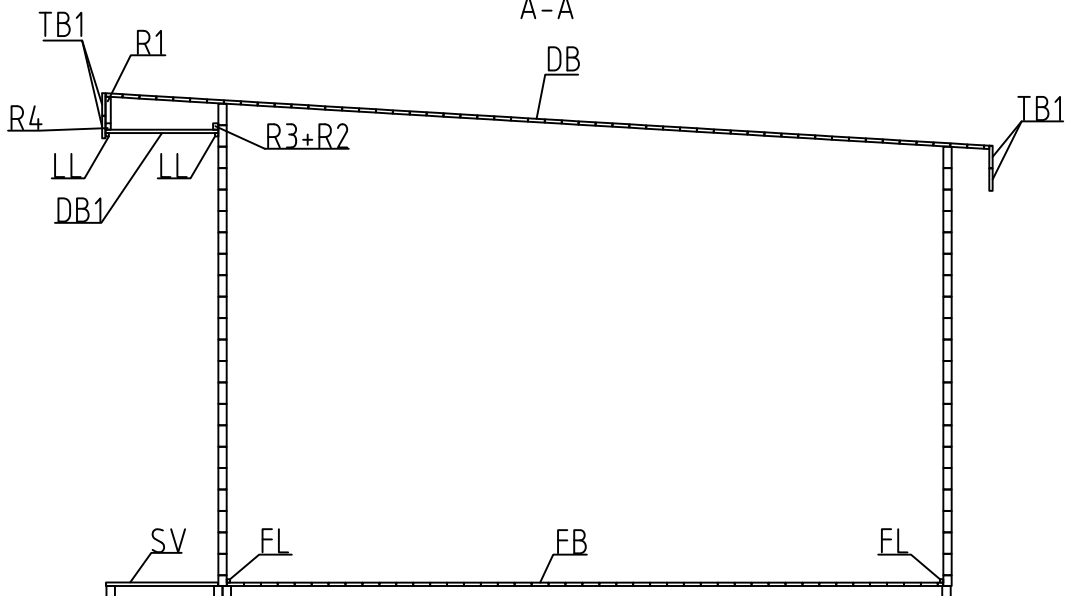

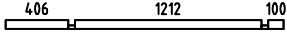

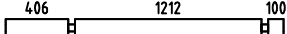
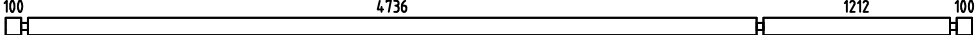
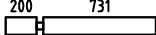
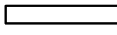
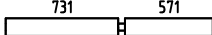
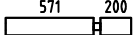
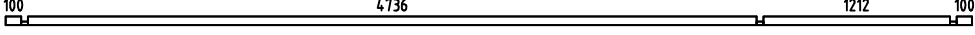
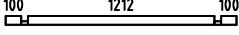
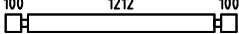
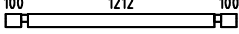
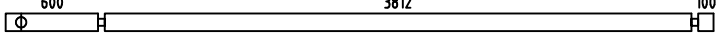
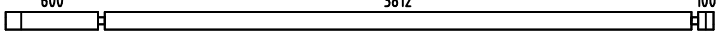
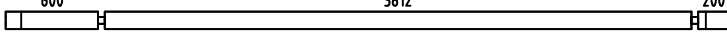
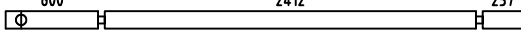

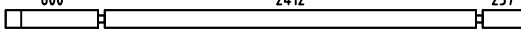
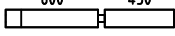
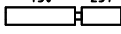
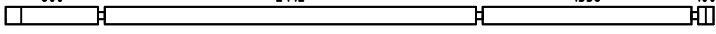
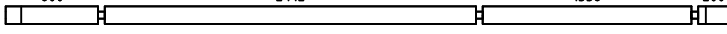
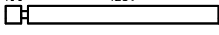
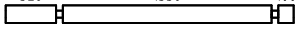



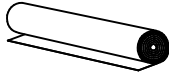
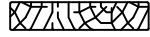
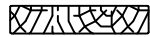



CROSS SECTION - SCHNITT - VU DE COUPE



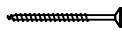
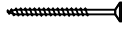
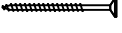
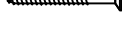

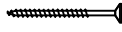
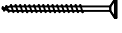
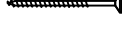
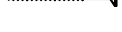

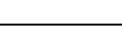
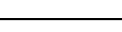



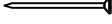



A-A

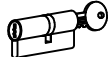

| Pos | 06.06.2014 | Piece list - Stückliste - Liste des pièces Art.Nr. 4415711 | 7/12 | Q. | P (mm) | L (mm) |
|-----|---|---|------|----|-----------|-----------|
| 001 |  | | | 1 | 44x57 | 550 |
| 002 |  | | | 1 | 44x57 | 1806 |
| 003 |  | | | 17 | 44x114 | 550 |
| 004 |  | | | 17 | 44x114 | 1806 |
| 005 |  | | | 23 | 44x114 | 6280 |
| 006 |  | | | 2 | 44x114 | 975 |
| 007 |  | | | 8 | 44x114 | 731 |
| 008 |  | | | 2 | 44x114 | 1346 |
| 009 |  | | | 2 | 44x114 | 815 |
| 010 |  | | | 1 | 44x57 | 6280 |
| 011 |  | | | 1 | 44x57 | 1500 |
| 012 |  | | | 20 | 44x114 | 1500 |
| 013 |  | | | 1 | 44x85 | 1500 |
| 014 |  | | | 1 | 44x114 | 4600 |
| 015 |  | | | 18 | 44x114 | 4600 |
| 016 |  | | | 1 | 44x114 | 4700 |
| 020 |  | | | 1 | 44x114 | 3357 |
| 021 |  | | | 17 | 44x114 | 400 |
| 022 |  | | | 12 | 44x114 | 3357 |
| 023 |  | | | 4 | 44x114 | 1094 |
| 024 |  | | | 4 | 44x114 | 751 |
| 025 |  | | | 2 | 44x114 | 4600 |
| 026 |  | | | 1 | 44x114 | 4700 |
| 029 |  | | | 17 | 44x114 | 1384 |
| 030 |  | | | 17 | 44x114 | 1872 |

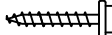
| Pos | 06.06.2014 | Piece list - Stückliste - Liste des pièces Art.Nr. 4415711 | 8/12 | Q. | P (mm) | L (mm) |
|------|---|---|------|----|-----------|-----------|
| 031 | | | | 2 | 44x114 | 4100 |
| 032 | | | | 1 | 44x114 | 4200 |
| WA-1 | | | | 1 | | |
| WB-1 | | | | 1 | | |
| WC-1 | | | | 1 | | |
| IAR3 | FOUNDATION - FUNDAMENT - FONDATION | | | 4 | 45x70 | 4797 |
| IAR2 | FOUNDATION - FUNDAMENT - FONDATION | | | 14 | 45x70 | 3783 |
| IAR4 | FOUNDATION - FUNDAMENT - FONDATION | | | 4 | 45x70 | 1273 |
| IAR1 | FOUNDATION - FUNDAMENT - FONDATION | | | 3 | 45x70 | 527 |
| SR1 | RAFTER - DACHSPARREN - CHEVRON | | | 6 | 70x140 | 4717 |
| FB | FLOOR BOARDS - FUSSBODENBRETTER - LAME DE PLANCHER | | | 43 | 90x18 | 4732 |
| FB | FLOOR BOARDS - FUSSBODENBRETTER - LAME DE PLANCHER | | | 43 | 90x18 | 1208 |
| DB2 | ROOF BOARDS - DACHBRETTER - VOLIGES | | | 53 | 90x18 | 3413 |
| DB3 | ROOF BOARDS - DACHBRETTER - VOLIGES | | | 53 | 90x18 | 3067 |
| DB1 | ROOF BOARDS - DACHBRETTER - VOLIGES | | | 67 | 90x18 | 596 |
| SV | TERRACE BOARDS - TERRASSENBRETTER - PLANCHER DE TERRASSE | | | 60 | 90x19 | 596 |
| LL | CEILING FILLET - DECKELEISTE - PROFIL DE FINITION SOUS PLAFOND | | | | 18x18 | 13.17 |
| FL | FLOOR FILLET-FUSSBODENLEISTE - CORNIERE DE FINITION DU PLANCHER | | | | 18x18 | 29.43 |
| M10 | TREADED ROD M10 - GEWINDESTANGE M10 - TIGE FILETÉE M10 | | | 2 | | 360 |
| M11 | TREADED ROD M10 - GEWINDESTANGE M10 - TIGE FILETÉE M10 | | | 2 | | 570 |
| M12 | TREADED ROD M10 - GEWINDESTANGE M10 - TIGE FILETÉE M10 | | | 4 | | 2000 |
| R1 | LATH - PFETTEN - LITEAU | | | 2 | 28x34 | 140 |
| R2 | LATH - PFETTEN - LITEAU | | | 2 | 28x34 | 570 |
| R3 | LATH - PFETTEN - LITEAU | | | 6 | 28x34 | 730 |
| R4 | LATH - PFETTEN - LITEAU | | | 2 | 28x34 | 2996 |

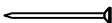
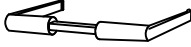
| Pos | 06.06.2014 | Piece list - Stückliste - Liste des pièces Art.Nr. 4415711 | 9/12 | Q. | P (mm) | L (mm) |
|-----|--|---|------|-----|-----------|-----------|
| DPP | ROOFING FELT - DACHPAPPE - FEUTRE BITUMEUX |  | | 6 | | 6580 |
| TB1 | EAVES BOARD - TRAUFBRETT - BANDEAU DE TOIT |  | | 8 | 18x120 | 3258 |
| TB2 | EAVES BOARD - TRAUFBRETT - BANDEAU DE TOIT |  | | 4 | 18x120 | 4715 |
| RP1 | EAVES SHEET - ABSCHLUSSPROFIL - PROFIL DE FINITION MÉTALLIQUE POUR DÉBORD DE TOITURE |  | | 4 | | 2200 |
| RP2 | EAVES SHEET - ABSCHLUSSPROFIL - PROFIL DE FINITION MÉTALLIQUE POUR DÉBORD DE TOITURE |  | | 4 | | 3100 |
| LD1 | LID FOR TREADED ROD HOLE - ABDECKUNG FÜR GEWINDESTANGENÖFFNUNG - COUVERCLE POUR ACCÈS RÉGLAGÉ TIGE FILETÉE |  | | 2 | | |
| | LENGTHENING BOLT FOR TREADED ROD - VERLÄNGERUNGSMUTTER FÜR GEWINDESTANGE - MANCHON DE RACCORDEMENT DE TIGE FILETÉE |  | | 4 | | |
| | DRIVE NUT TREADED ROD - EINSHLAGMUTTER FÜR GEWINDESTANGE - ÉCROU A FRAPPER POUR TIGE FILETÉE |  | | 4 | | |
| | NUT FOR TREADED ROD - MUTTER FÜR GEWINDESTANGE - ÉCROU POUR TIGE FILETÉE |  | | 4 | | |
| | PLAIN WASHER TREADED ROD - UNTERLEGSSCHEIBE FÜR GEWINDESTANGE - RONDELLE PLATE POUR TIGE FILETÉE |  | | 4 | | |
| | SCREW FOR LOCK COVERS - SCHRAUBE FÜR SCHLOSSBLENDEN VIS POUR SET DE GARNITURES DE SERRURE DE PORTE |  | | 4 | 3.5x15 | |
| | SCREW FOR SLIDING DOOR ROLLER- SCHRAUBE FÜR SCHIEBETÜR LAUFRAD - VIS POUR FERRURE DE PORTE COULISSANTE |  | | 8 | 3x30 | |
| | SCREW FOR DOOR FILLET - SCHRAUBE ZUR BEFESTIGUNG TÜRLEISTE - VIS D'ASSEMBLAGE DU CADRE DE PORTE |  | | 5 | 3x30 | |
| | SCREW FOR DOOR HANDLE FITTINGS - SCHRAUBE FÜR TÜRGRIF - VIS POUR SET DE GARNITURES DE SERRURE DE PORTE |  | | 16 | 3x30 | |
| | SCREW FOR ROOF LATH - SCHRAUBE FÜR DACHLATTE - VIS POUR LATTE |  | | 33 | 4x40 | |
| | SCREW FOR EAVES BOARDS - SCHRAUBEN FÜR TRAUFBRETT - VIS DE FIXATION POUR BANDEAU DE TOIT |  | | 106 | 4x40 | |
| HS4 | SCREW FOR DOOR COVERING MOULDING - SCHRAUBEN FÜR DECKUNGSPROFIL - VIS DE FIXATION PROFILS DE FINITION VERTICAUX A FIXER A L'EXTERIEUR DU CADRE DE LA PORTE |  | | 20 | 4x40 | |
| | SCREW FOR ROOF BEAMS - SCHRAUBEN FÜR DACHBALKEN - VIS POUR PANNE DE TOIT |  | | 18 | 5x120 | |
| HS1 | SCREW FOR DOOR JAMB - SCHRAUBE FÜR TÜRRAHMEN - VIS DE FIXATION POUR MONTANT DE PORTE |  | | 4 | 5x120 | |
| | SCREW FOR GABLE - SCHRAUBEN FÜR GIEBEL - VIS POUR FIXATION DES PIGNONS |  | | 18 | 5x120 | |
| | SCREW FOR 1. WALL BEAM - SCHRAUBE FÜR 1. BOHLENREIHE - VIS DE FIXATION DES FONDATIONS |  | | 12 | 5x90 | |
| | SCREW FOR FUNDAMENT - SCHRAUBEN ZUR BEFISTIGUNG FUNDAMENT - VIS POUR FONDATION |  | | 54 | 5x90 | |
| HS2 | SCREW FOR DOOR JAMB - SCHRAUBE FÜR TÜRRAHMEN - VIS DE FIXATION POUR MONTANT DE PORTE |  | | 4 | 5x90 | |
| HS3 | SCREW FOR FIXING DOOR - SCHRAUBE FÜR BEFISTIGUNG TÜR- VIS POUR FIXATION DE PORTE |  | | 16 | 5x90 | |
| | SCREW FOR DET 006,007,008,009 - SCHRAUBE FÜR DET 006,007,008,009 - VIS POUR DET 006,007,008,009 |  | | 28 | 6x180 | |

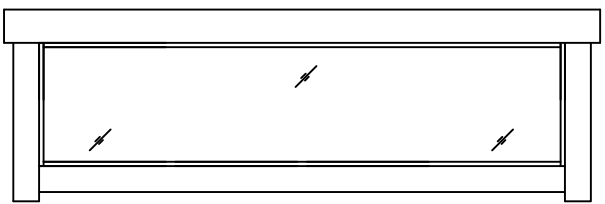
| Pos | 06.06.2014 | Piece list - Stückliste - Liste des pièces Art.Nr. 4415711 | 10/12 | Q. | P (mm) | L (mm) |
|-----|------------|---|---|-----|-----------|-----------|
| | | ZN NAIL FOR TERRACE - ZN NÄGEL FÜR TERRASSENBRETT - POINTE POUR PLANCHER DE TERRASSE |  | 244 | 2.1x50 | |
| | | ZN NAIL FOR CEILING FILLET - ZN NÄGEL DECKELEISTE - POINTE POUR PROFIL DE FINITION SOUS PLAFOND |  | 27 | 1.4x40 | |
| | | ZN NAIL FOR FLOOR FILLET - ZN NÄGEL FÜR FUSSBODENLEISTE - POINTE POUR CORNIERE DE FINITION DU PLANCHER |  | 60 | 1.4x40 | |
| | | HAMMER BLOCK - SCHLAGHOLZ - CALLE DE FRAPPE |  | 1 | | |
| | | ROLLER FOR SLIDING DOOR - LAUFRAD FÜR SCHIEBETÜR - FERRURE POUR PORTE COULISSANTE |  | 4 | | |
| | | DOOR HANDLE FITTINGS - TÜRGRIF - SET DE GARNITURES DE SERRURE DE PORTE |  | 4 | | |
| | | CYLINDER - ZYLINDERSCHLOSS - CYLINDRE DE SERRURE |  | 1 | | |
| | | SET OF DOOR LOCK COVERS - SCHLOSSBLENDEN - SET DE GARNITURES DE SERRURE DE PORTE |  | 2 | | |
| | | SCREW FOR DOORSTEP - SCHRAUBEN FÜR TÜRSCHWELLE - VIS DE FIXATION DU SEUIL DE PORTE |  | 4 | 4.5x65 | |
| | | ROOFING NAILS FOR ROOFING FELT - NÄGEL FÜR DACHPAPPE - POINTE DE FIXATION POUR FEUTRE BITUMEUX |  | 315 | 2.8x15 | |
| | | SCREW FOR EAVES SHEET - SCHRAUBE FÜR ABSCHLUSSPROFIL - VIS POUR PROFIL DE FINITION MÉTALLIQUE POUR DÉBORD DE TOITURE |  | 56 | 4.8x28 | |
| RPN | | EAVES SHEET CORNER - ECKPROFIL- PROFIL D'HABILLAGE DE RIVES |  | 4 | | |
| | | ZN NAIL FOR ROOF - ZN NÄGEL FÜR DACHBRETT - POINTE POUR TOIT |  | 888 | 2x50 | |
| | | ZN NAIL FOR FLOOR - ZN NÄGEL FÜR FUSSBODENBRETT - CLOUS POUR PLANCHER |  | 528 | 2x50 | |
| | | DOOR HANDLE FITTINGS-TÜRGRIF - SET DE GARNITURES DE SERRURE DE PORTE |  | 2 | | |
| | | SET OF DOOR LOCK COVERS - SCHLOSSBLENDEN - SET DE GARNITURES DE SERRURE DE PORTE |  | 2 | | |
| | | CYLINDER - ZYLINDERSCHLOSS - CYLINDRE DE SERRURE |  | 2 | | |
| | | WINDOW - FENSTER - FENETRE 1500x410 AK.1.100.PMO.k | DGP | 1 | | |
| | |  | | | | |

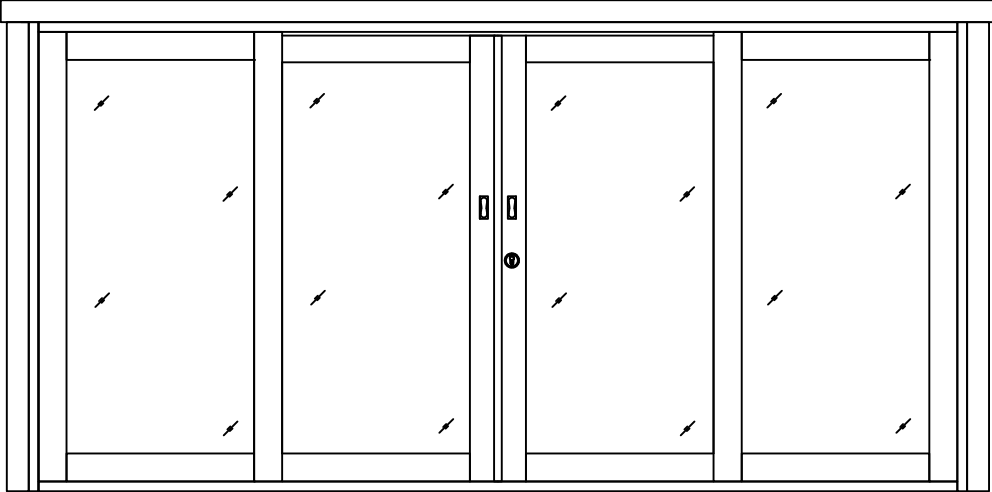
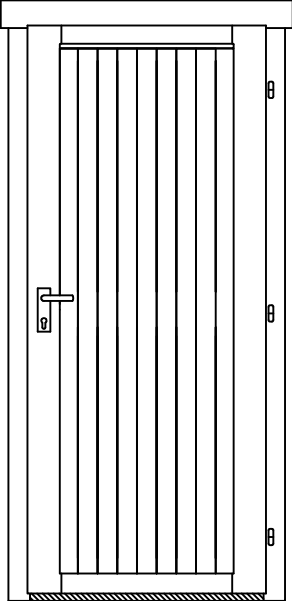
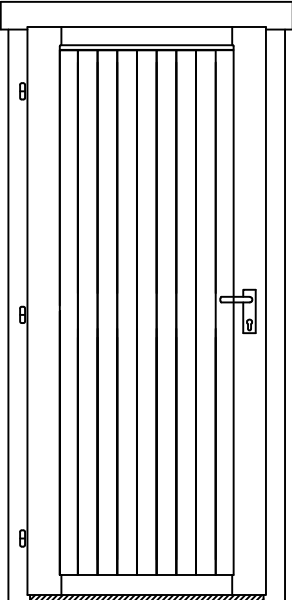
| Pos | 06.06.2014 Piece list - Stückliste - Liste des pièces Art.Nr. 4415711 | 11/12 | Q. | P (mm) | L (mm) |
|-----|--|-------|----|-----------|-----------|
| | DOOR - TÜR - PORTE 3914x1957 TUK.1100.PLP.MMf DGP  | 1 | | | |
| | DOOR - TÜR - PORTE 835x1900 UL.2.100.IVP.MMWd DGP  | 1 | | | |
| | DOOR - TÜR - PORTE 835x1900 UL.2.100.IVV.MMWd DGP  | 1 | | | |

1

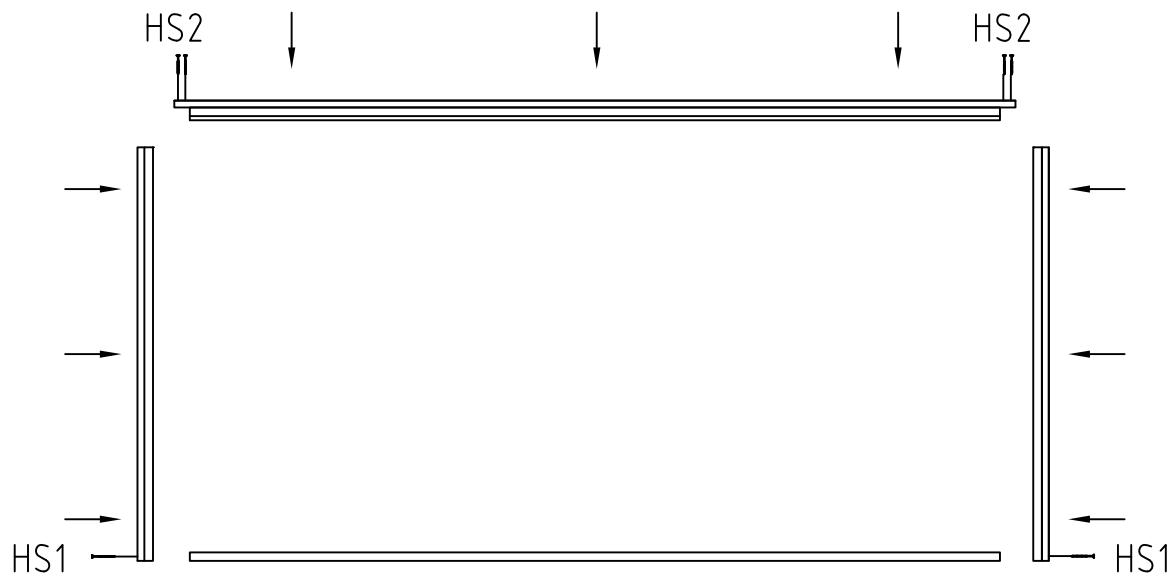

2

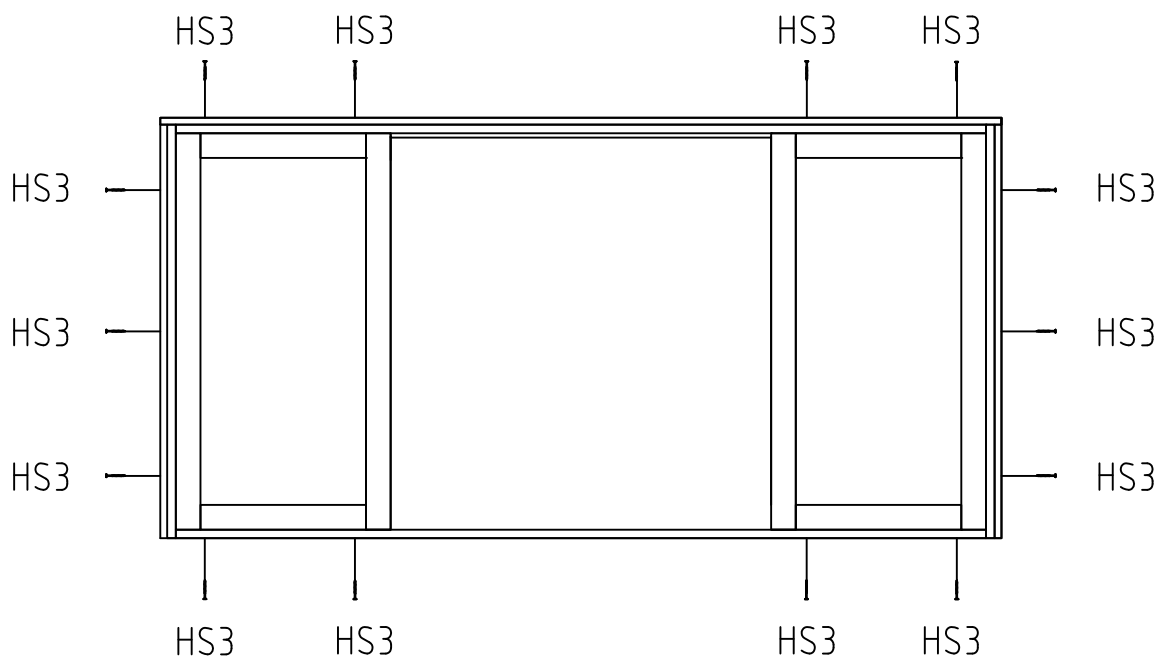

3

