

Valentin
Art. Nr. 4421896
1/9

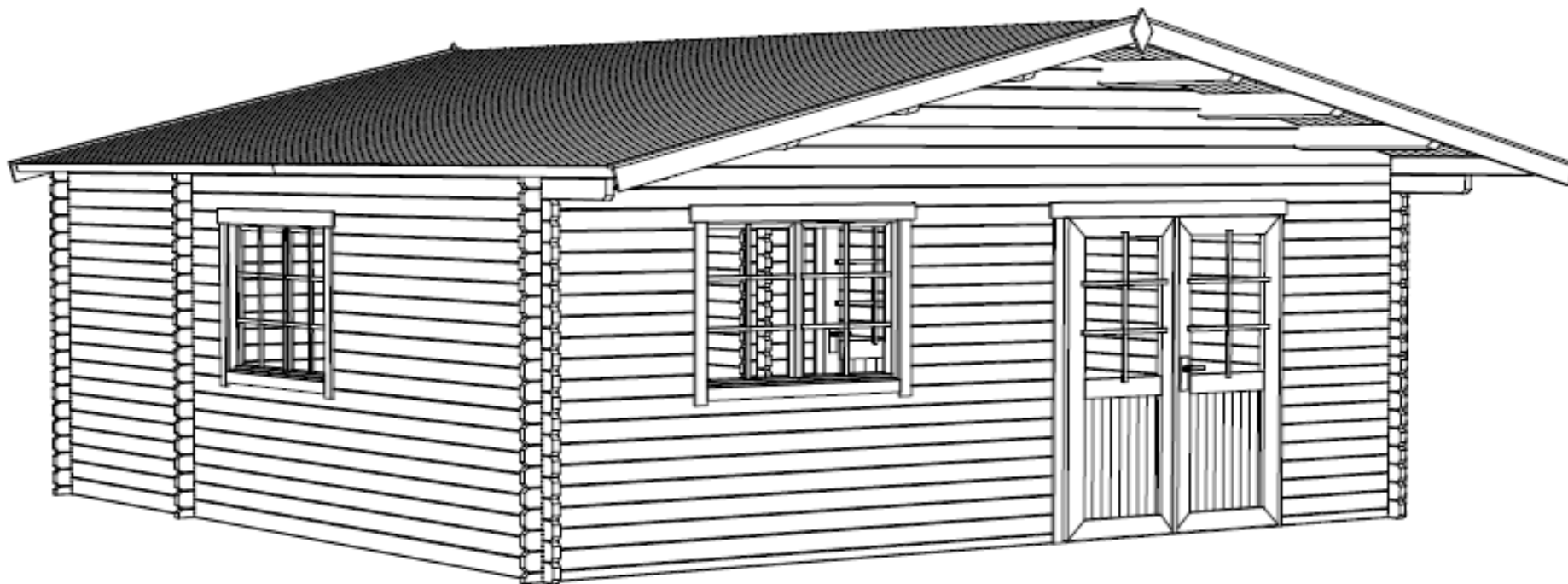

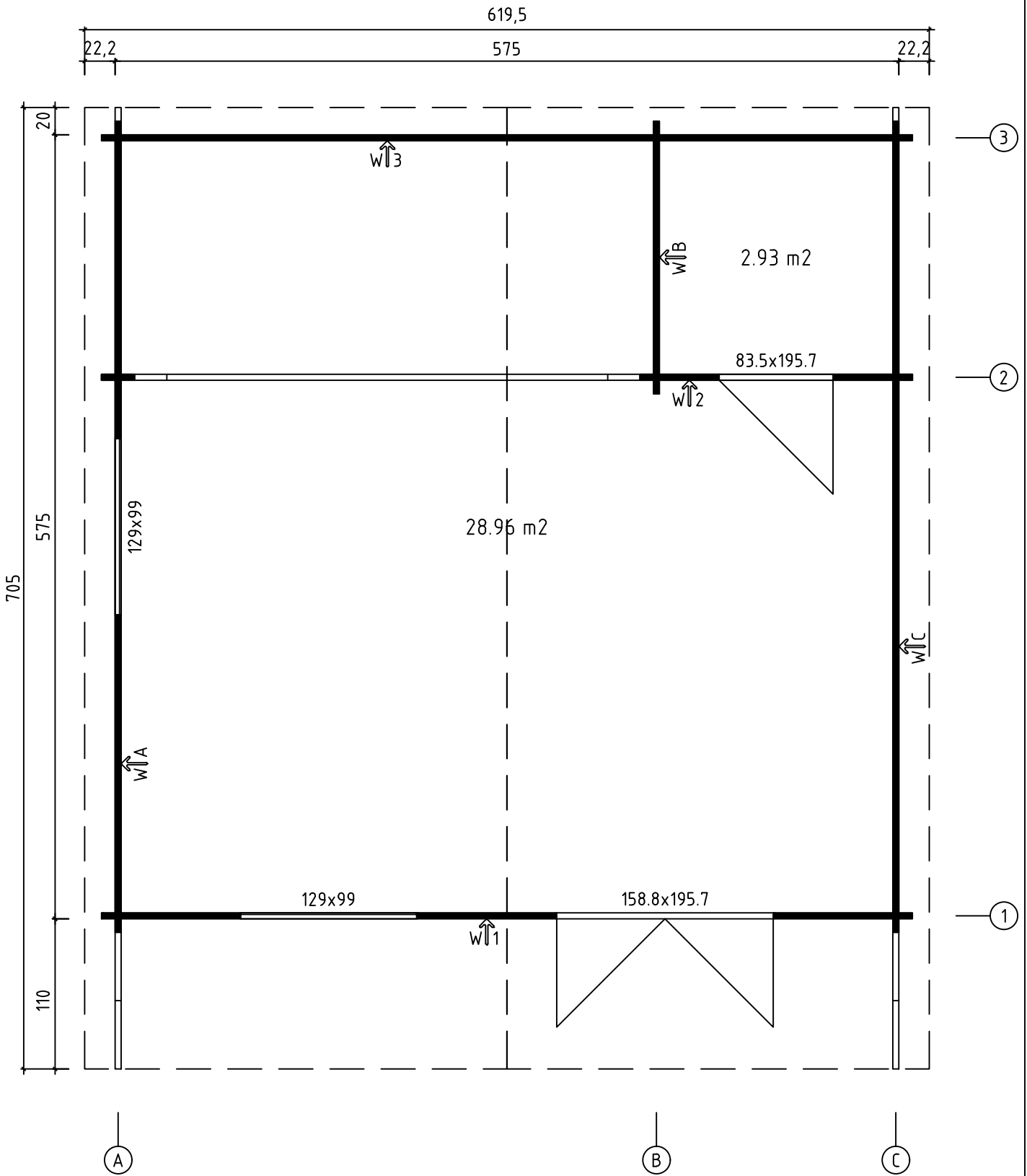

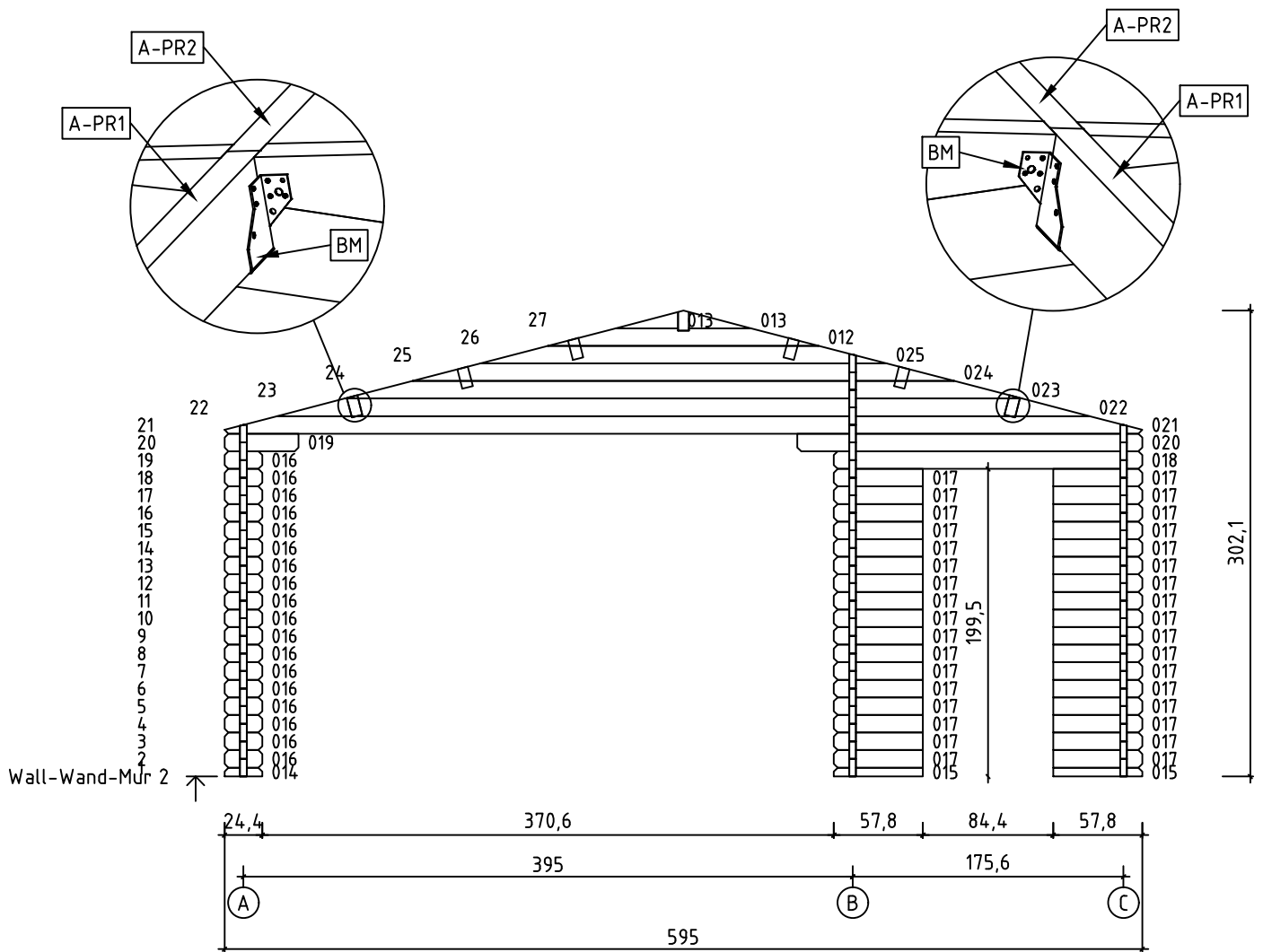

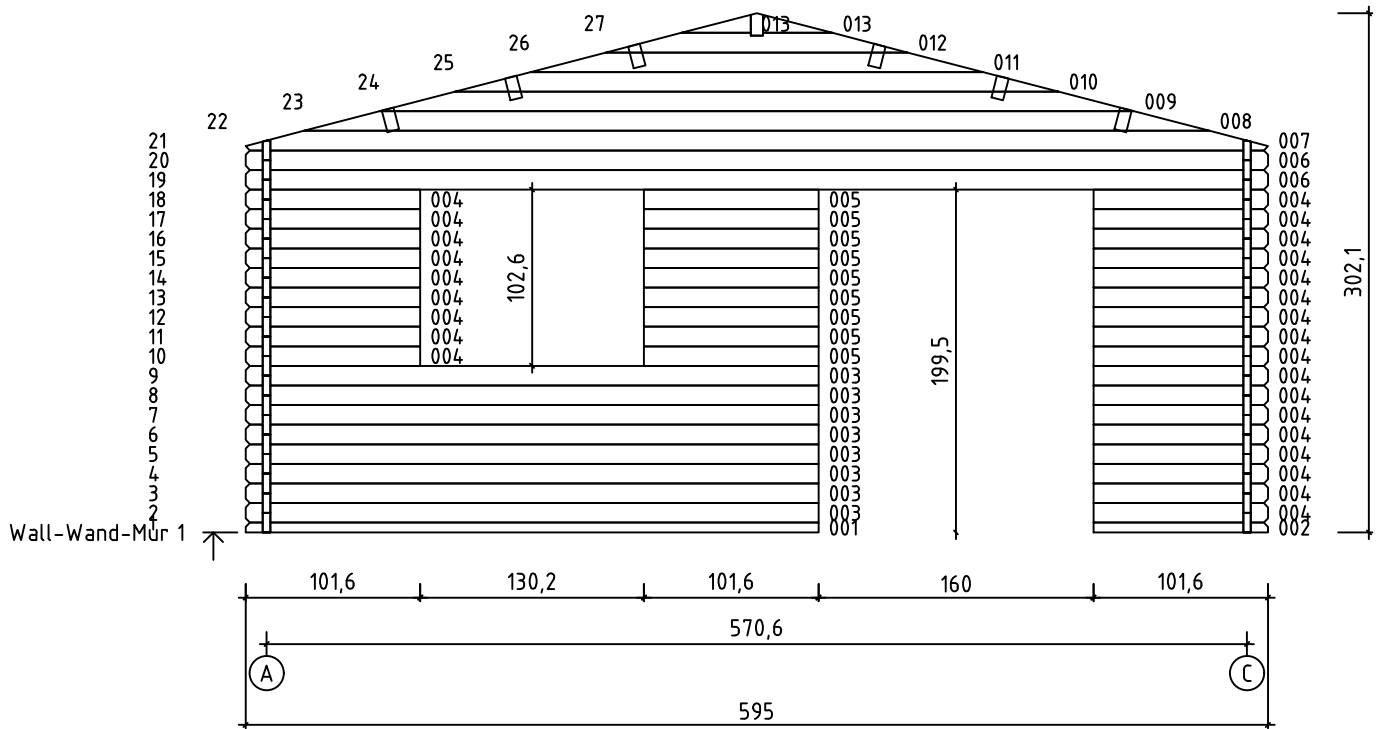

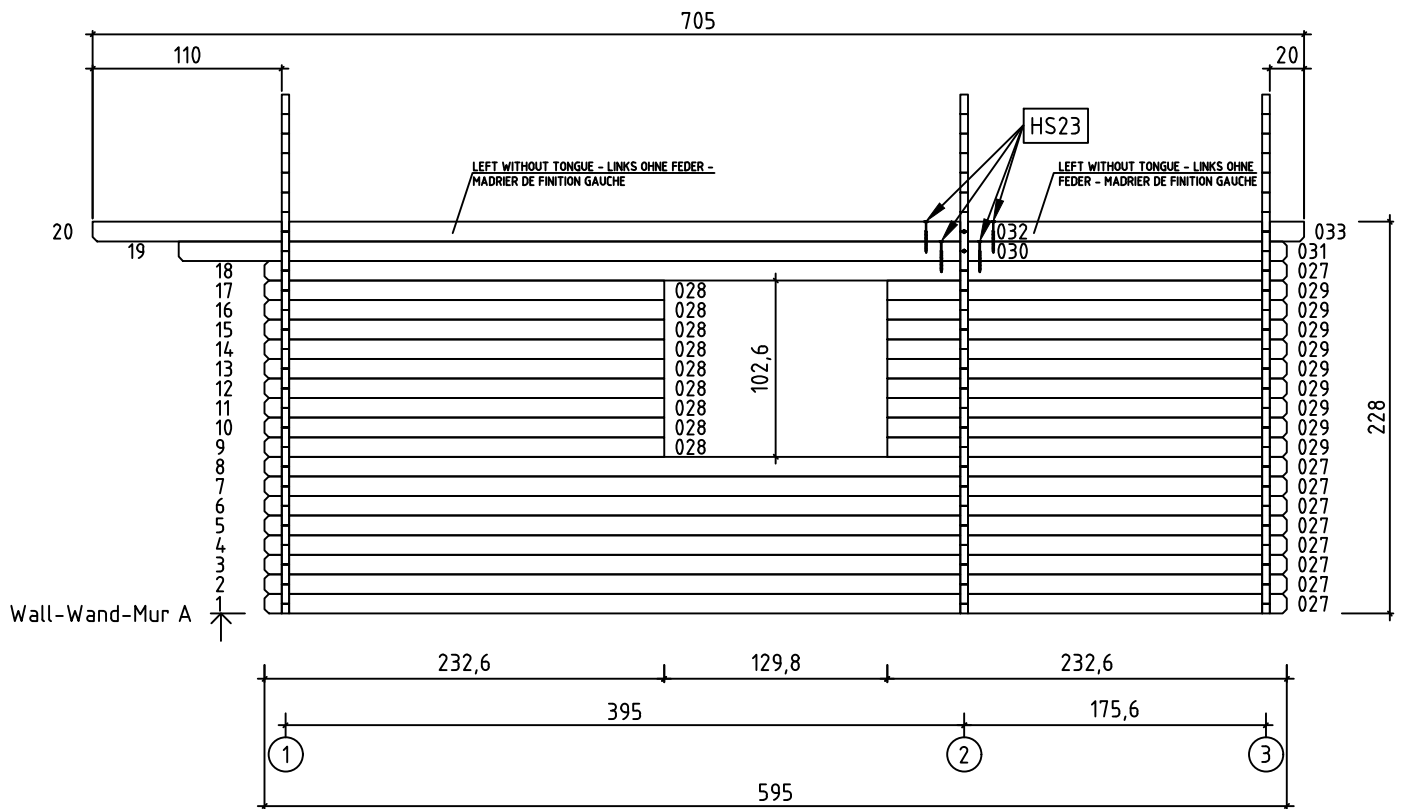
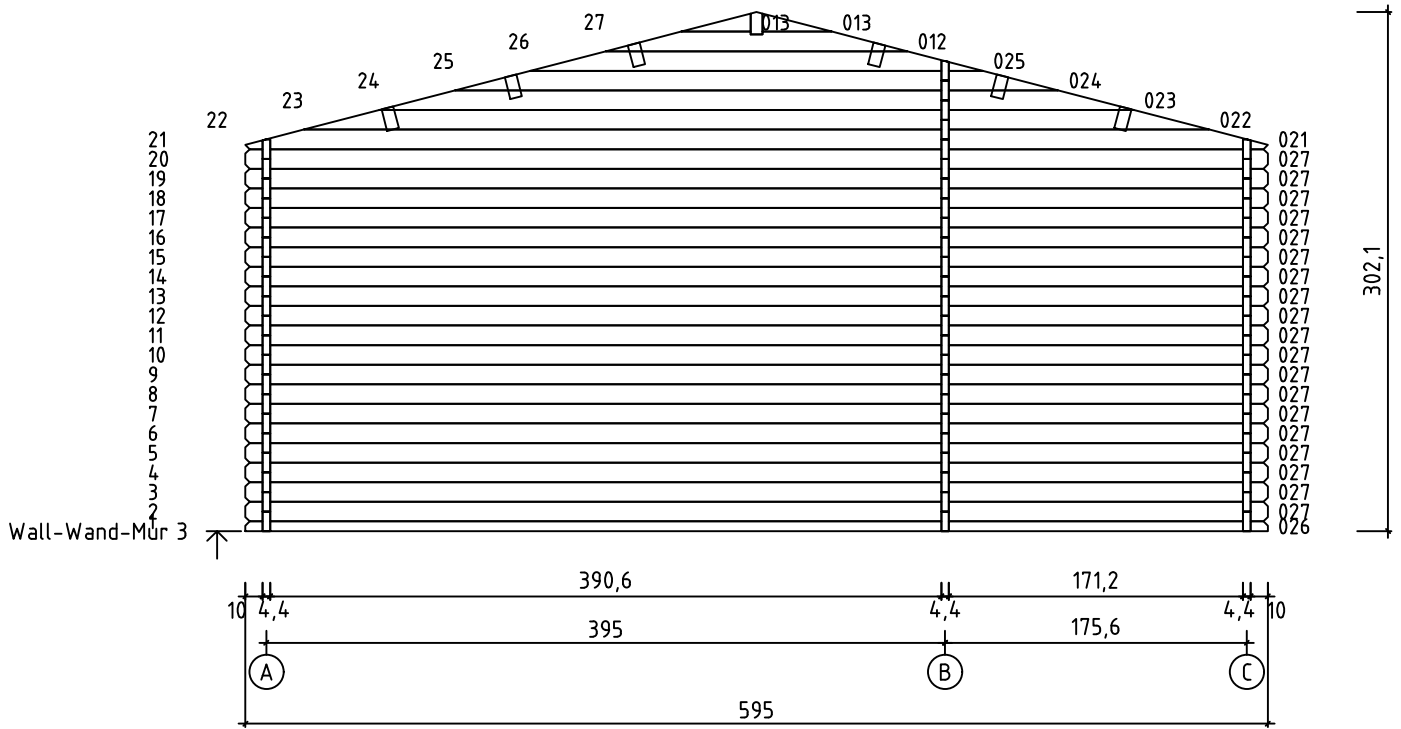

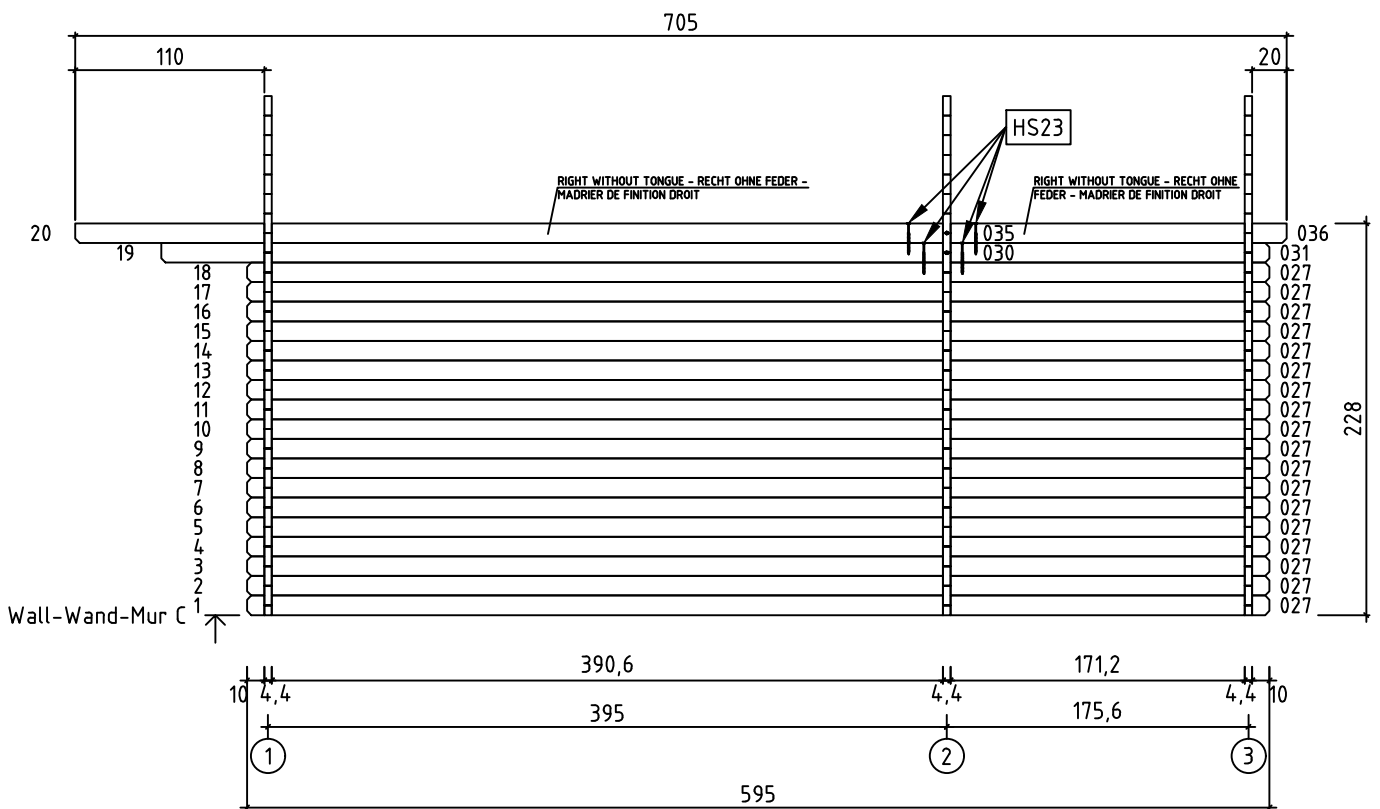
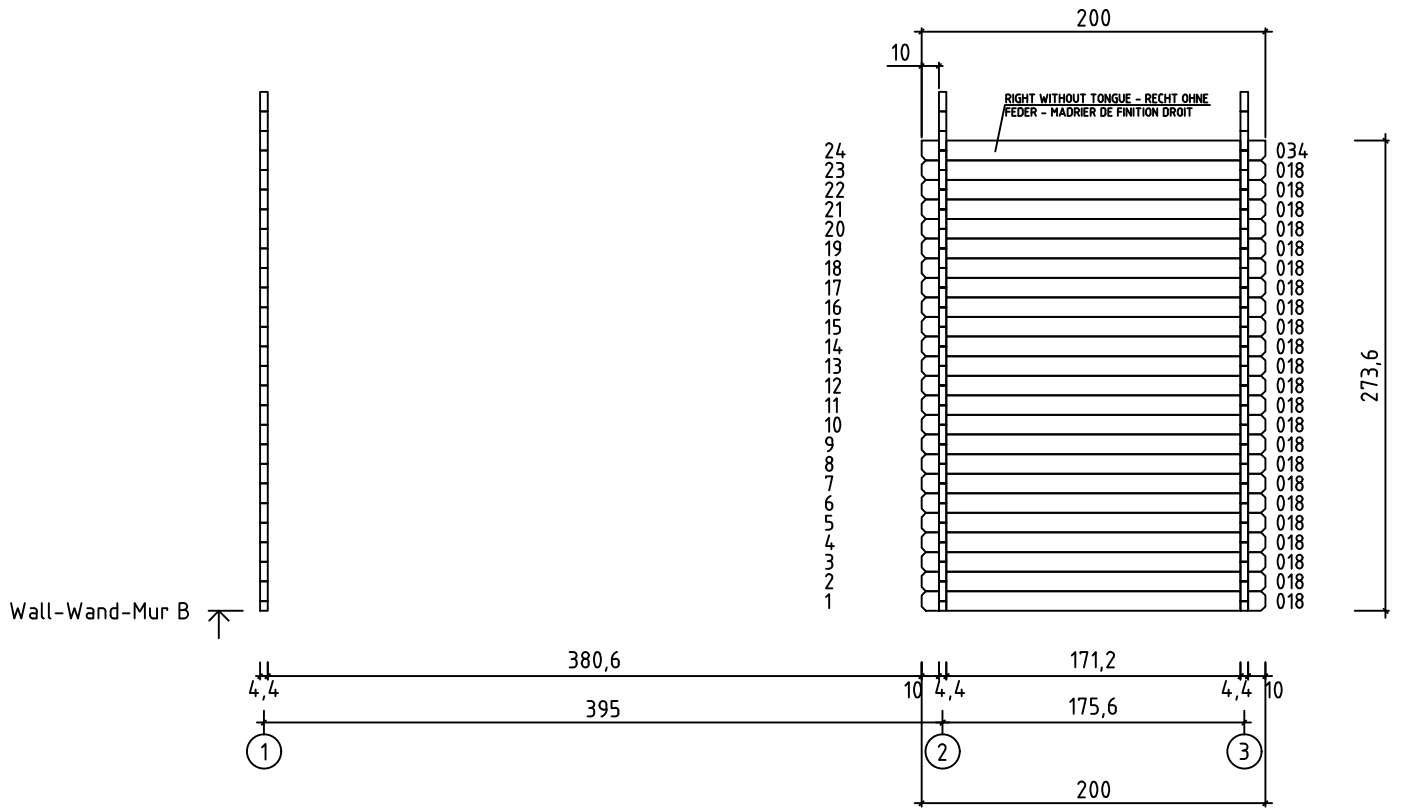

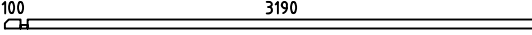
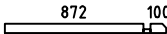
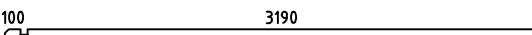
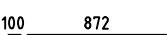
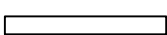
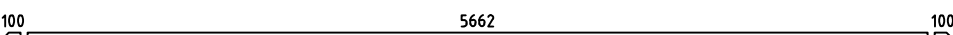

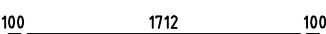

GROUNDPLAN - GRUNDPLAN - PLAN DE MASSE

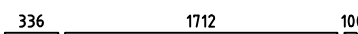

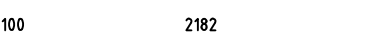

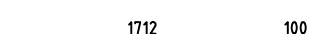

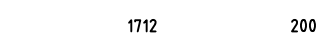
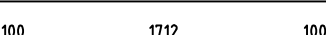

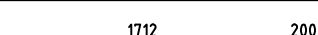

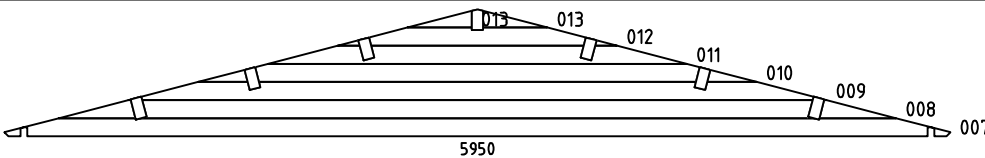
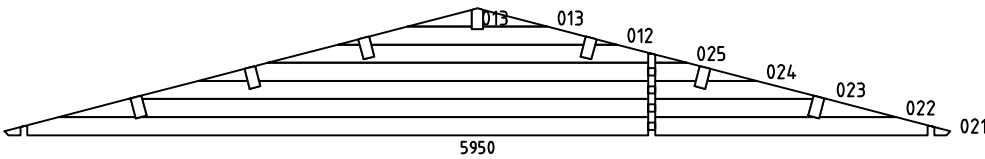
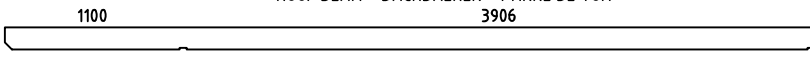
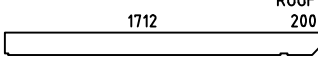
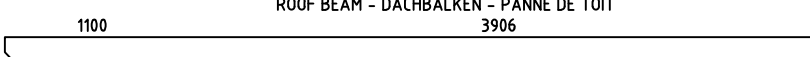
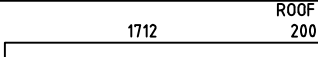



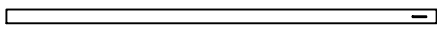
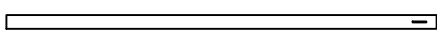
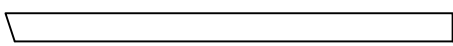

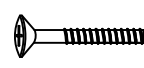

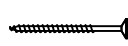



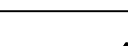
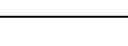

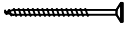
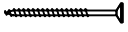
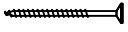
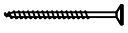

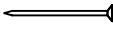
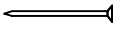
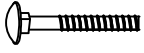

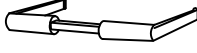

Pos	15.11.2016	Piece list - Stückliste - Liste des pièces Art. Nr. 4421896	6/9	Q	P (mm)	L (mm)
001				1	44x57	3334
002				1	44x57	1016
003				8	44x114	3334
004				26	44x114	1016
005				9	44x114	1016
006				2	44x114	5950
014				1	44x57	244
015				2	44x57	578
016				18	44x114	244
017				34	44x114	578
018				24	44x114	2000
019				1	44x114	480
020				1	44x114	2236
026				1	44x57	5950
027				46	44x114	5950
028				9	44x114	2326
029				9	44x114	2326
030				2	44x114	4572
031				2	44x114	1878
032				1	44x120	5072
033				1	44x120	1978
034				1	44x120	2000
035				1	44x120	5072
036				1	44x120	1978

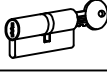
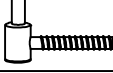
Pos	15.11.2016	Piece list - Stückliste - Liste des pièces Art. Nr. 4421896	7/9	Q	P (mm)	L (mm)
W1-1	789			1		
W2-1 W3-1	789			1 1		
PR1		ROOF BEAM - DACHBALKEN - PANNE DE TOIT 		1	70x140	5072
PR2		ROOF BEAM - DACHBALKEN - PANNE DE TOIT 		1	70x140	1978
A-PR1		ROOF BEAM - DACHBALKEN - PANNE DE TOIT 		6	70x140	5072
A-PR2		ROOF BEAM - DACHBALKEN - PANNE DE TOIT 		6	70x140	1978
		ROOF BOARDS - DACHBRETTER - VOLIGES 		158	90x18	3200
		ROOFING FELT FILLET - DACHPAPPENLEISTE - BAGUETTE DE FIXATION DU FEUTRE BITUMEUX 		4	18x58	3250
TB-1		FASCIA BOARD - TRAUFBRETT - BANDEAU DE TOIT 		4	18x58	3525
KFS-1		STORM PROTECTION - STURMLEISTE - LATTE ANTI-TEMPETE 		5	22x45	2500
KFS-2		STORM PROTECTION - STURMLEISTE - LATTE ANTI-TEMPETE 		1	22x45	2700
		GABLE MOULDING - GIEBELLEISTE - PLANCHE DE RIVE 		4	18x120	3250
FS1		WINDOW HANDLE FITTINGS - FENSTERGRIFF - POIGNEE DE FENETRE 		2		
FSP		BOLT FOR WINDOW HANDLE FITTINGS - BOLZEN FÜR FENSTERGRIFF BESCHLAG - VIS POUR FIXATION POIGNEE DE FENETRE 		4		
HS1		SCREW FOR GEORGIAN BARS - SCHRAUBE FÜR SPROSSEN - VIS DE BARRES GEORGIANNE 		42	2.5x20	
HS8		SCREW FOR GABLE SEGMENT - SCHRAUBEN FÜR DECKBLATT - VIS POUR FIXATION LOSANGE DE FINITION 		4	3.5x35	
HS9		SCREW FOR GABLE MOULDING - SCHRAUBEN FÜR GIEBELLEISTE - VIS POUR FIXATION PLANCHE DE RIVE 		40	3.5x50	
HS4		SCREW FOR WINDOW FILLET - SCHRAUBE FÜR GLASLEISTE - VIS DE FILET DE FENETRE 		6	3x30	
HS4		SCREW FOR DOOR FILLET - SCHRAUBE ZUR BEFESTIGUNG TÜRLEISTE - VIS POUR FIXATION BAGUETTE D'ARRET DE PORTE 		3	3x30	
HS12		SCREW FOR FASCIA BOARDS - SCHRAUBEN FÜR TRAUFBRETTER - VIS POUR FIXATION BANDEAU DE TOIT 		32	4x40	
HS12		SCREW FOR BEAM HOLDER - SCHRAUBEN FÜR BALKENHALTER - VIS DE FIXATION SUPPORT "U" GALVANISÉ 		168	4x40	
HS18		SCREW FOR GABLE - SCHRAUBEN FÜR GIEBEL - VIS POUR FIXATION DES PIGNONS 		8	5x120	
HS18		SCREW FOR ROOF BEAMS - SCHRAUBEN FÜR DACHBALKEN - VIS POUR FIXATION PANNES DE TOIT 		21	5x120	

Pos	15.11.2016	Piece list - Stückliste - Liste des pièces Art. Nr. 4421896	8/9	Q	P (mm)	L (mm)
HS18	SCREW FOR GABLE - SCHRAUBEN FÜR GIEBEL - VIS POUR FIXATION DES PIGNONS		32	5x120		
HS16	SCREW FOR DOOR JAMB - SCHRAUBE FÜR TÜRRAHMEN - VIS DE FIXATION PARTIE HAUTE AVEC MONTANTS DU CADRE DE PORTE		4	5x90		
HS23	SCREW FOR WALL DETAILS - SCHRAUBE FÜR WAND DETAILS - VIS POUR MUR DETAILS		8	6x180		
HS25	SCREW FOR DOORSTEP - SCHRAUBEN FÜR SWELLE - VIS POUR FIXATION BARRE DE SEUIL		5	4.5x65		
SH44	HAMMER BLOCK - SCHLAGHOLZ - CALLE DE FRAPPE		1			
SFS	NUT FOR STORM PROTECTION - SCHRAUBENMUTTER FÜR STURMLEISTE - ECROU POUR LATTE ANTI-TEMPETE		12	D8		
NF4	ZN NAIL FOR ROOF - ZN NÄGEL FÜR DACHBRETTER - POINTE POUR FIXATION VOLIGES DE TOIT		850	2x50		
NF5	ZN NAIL FOR ROOFING FELT FILLET - ZN NÄGEL FÜR DACHPAPPENLEISTE - POINTE POUR BAGUETTE DE FIXATION FEUTRE BITUMEUX		32	2x40		
BFS	BOLT FOR STORM PROTECTION - BOLZEN FÜR STURMLEISTE - BOULON POUR LATTE ANTI-TEMPETE		12	8x80		
GS	GABLE SEGMENT - DECKBLATT - LOSANGE DE FINITION		2			
DFS	WASHER FOR STORM PROTECTION - DICHTSCHEIBE FÜR STURMLEISTE - RONDELLE POUR LATTE ANTI-TEMPETE		12	D8		
BM	BEAM HOLDER - BALKENHALTER - SUPPORT EN U GALVANISÉ		14	73x123		
TL4	DOOR HANDLE FITTINGS - TÜRGRIF - POIGNEE DE PORTE		2			
TL5	SET OF DOOR LOCK COVERS - SCHLOSSBLENDEN - SET DE GARNITURES DE PORTE		2			
	CYLINDER LOCK - ZYLINDERSCHLOSS - BARILLET DE PORTE		2	30/35		
	MALE BOLT HINGE FOR DOOR - TÜRRIEGEL - PARTIE MALE DE PAUMELLE DE PORTE		6	16/52		
	STRIKER FOR BARREL BOLT - HÜLSE FÜR GRENDELRIEGEL - GACHE AU SOL DU TARGETTE		2			
	DOOR - TÜR - PORTE 1588x1957 SGC	TUK.2.056.SVP.MM	1			
