

*Elgin 70*  
Art.No. 7012902

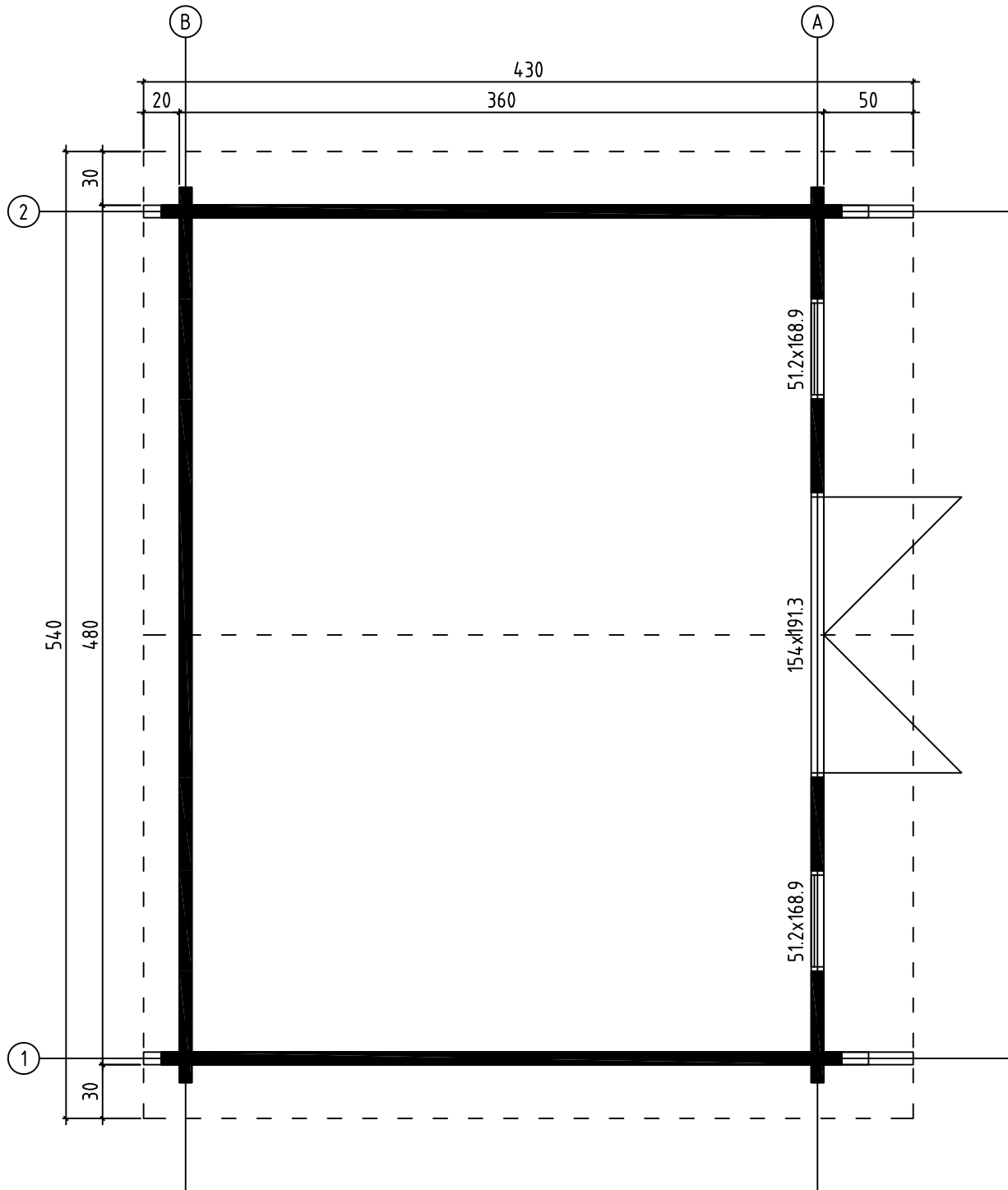

Elgin 70, Art.No.7012902  
GROUNDPLAN - GRUNDPLAN - PLAN DE MASSE

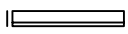

 51.2x168.9

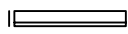
 51.2x168.9

Elgin 70, Art.No.7012902  
FOUNDATION - FUNDAMENT - FONDATION

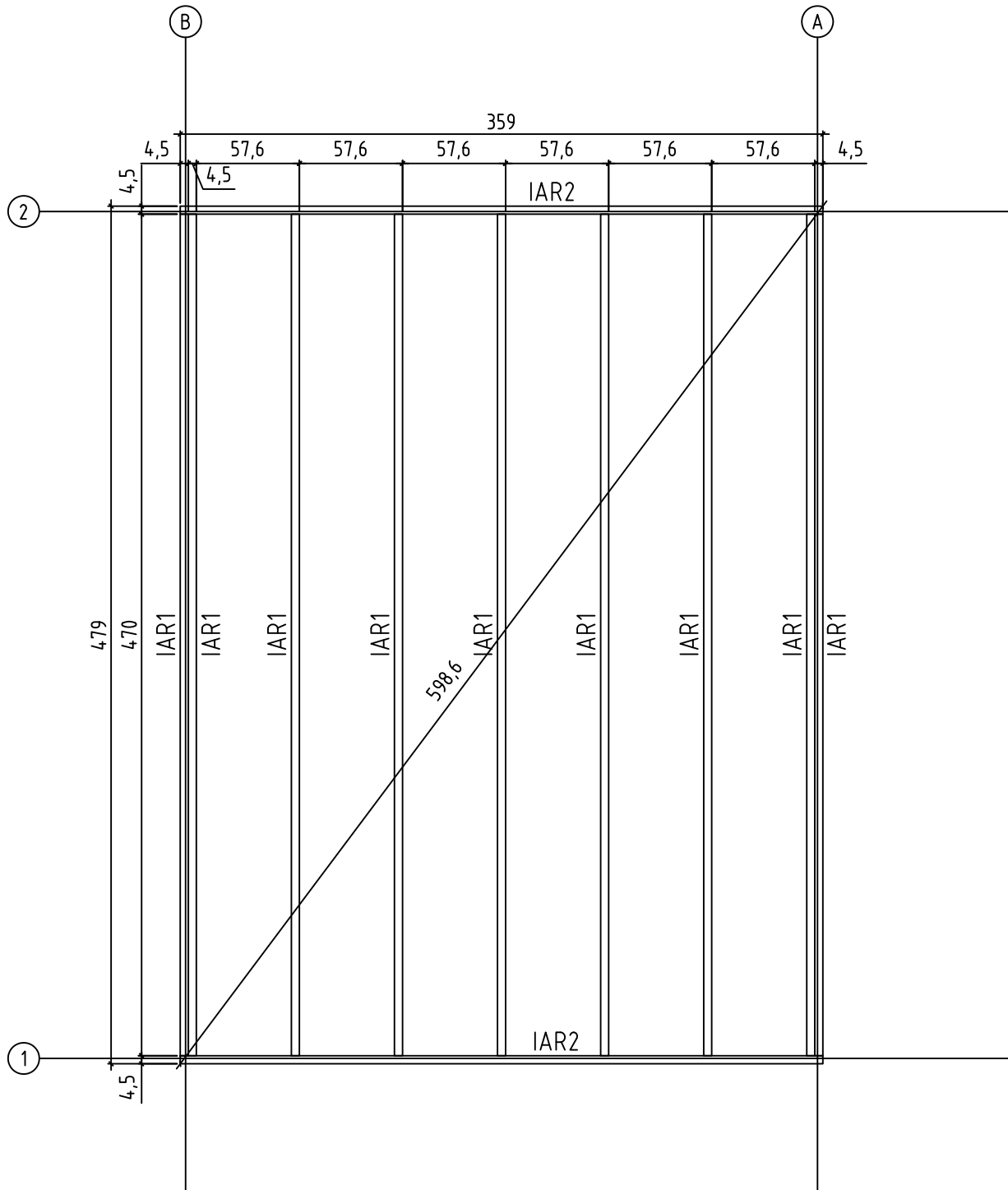

Elgin 70, Art.No.7012902  
FLOOR BOARDS - FUSSBODENBRETTER - PLAN POSE PLANCHER

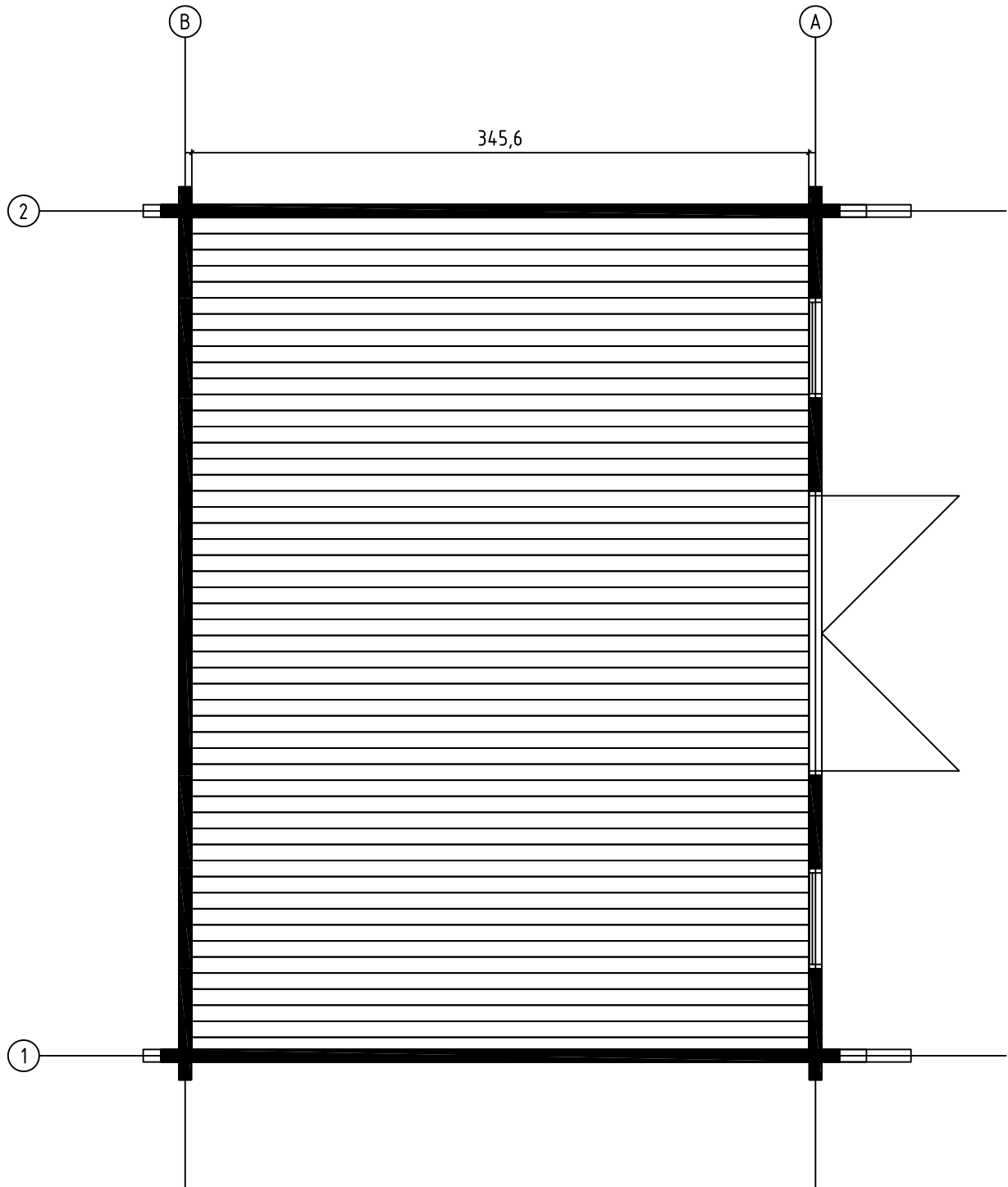

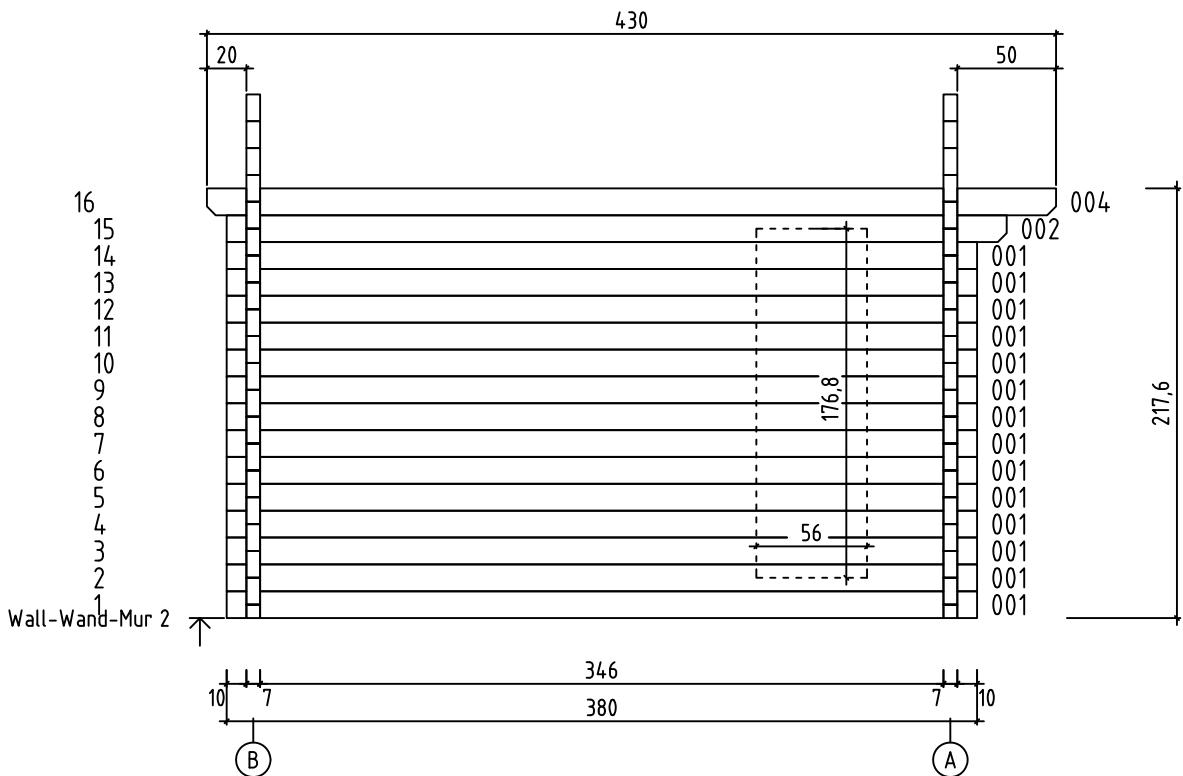
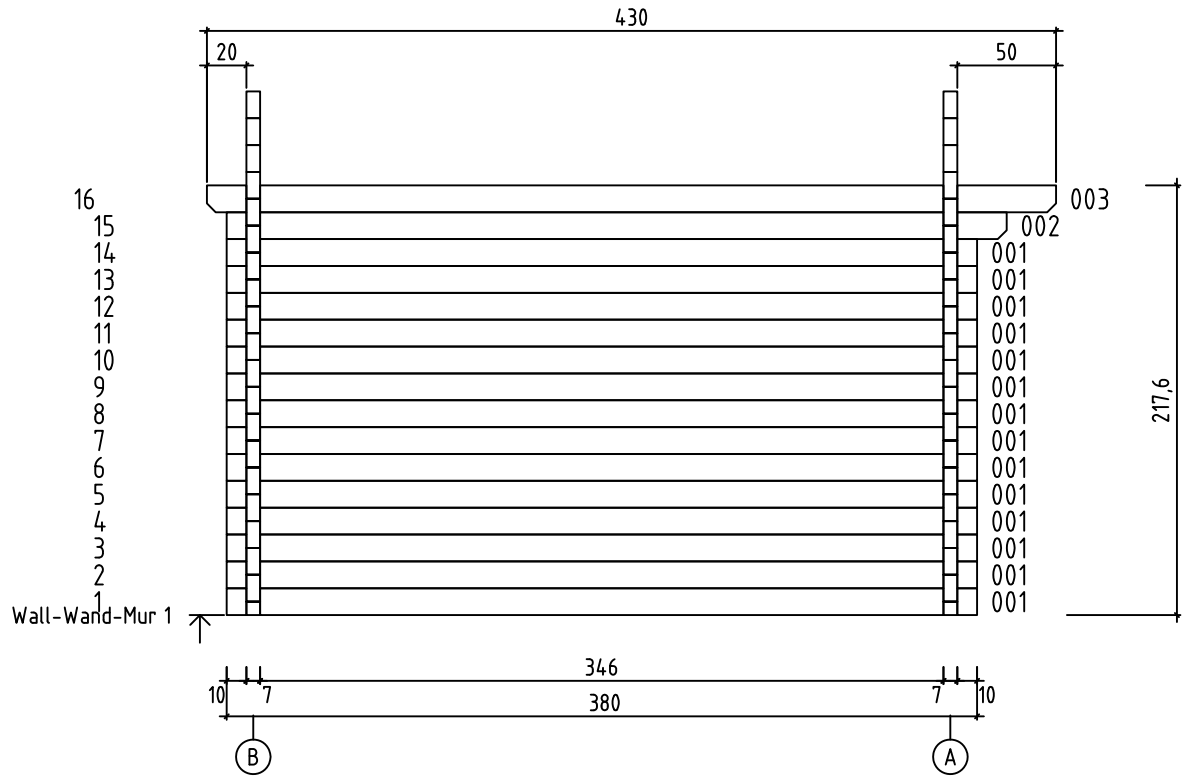







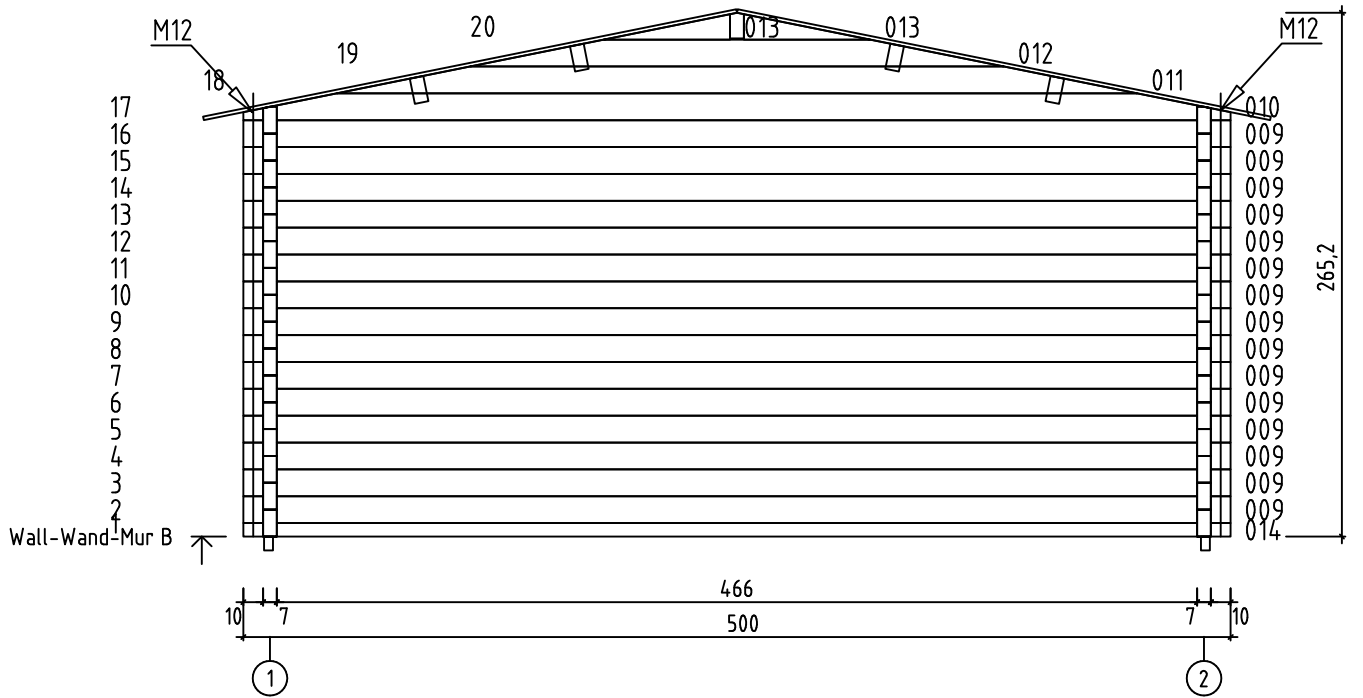
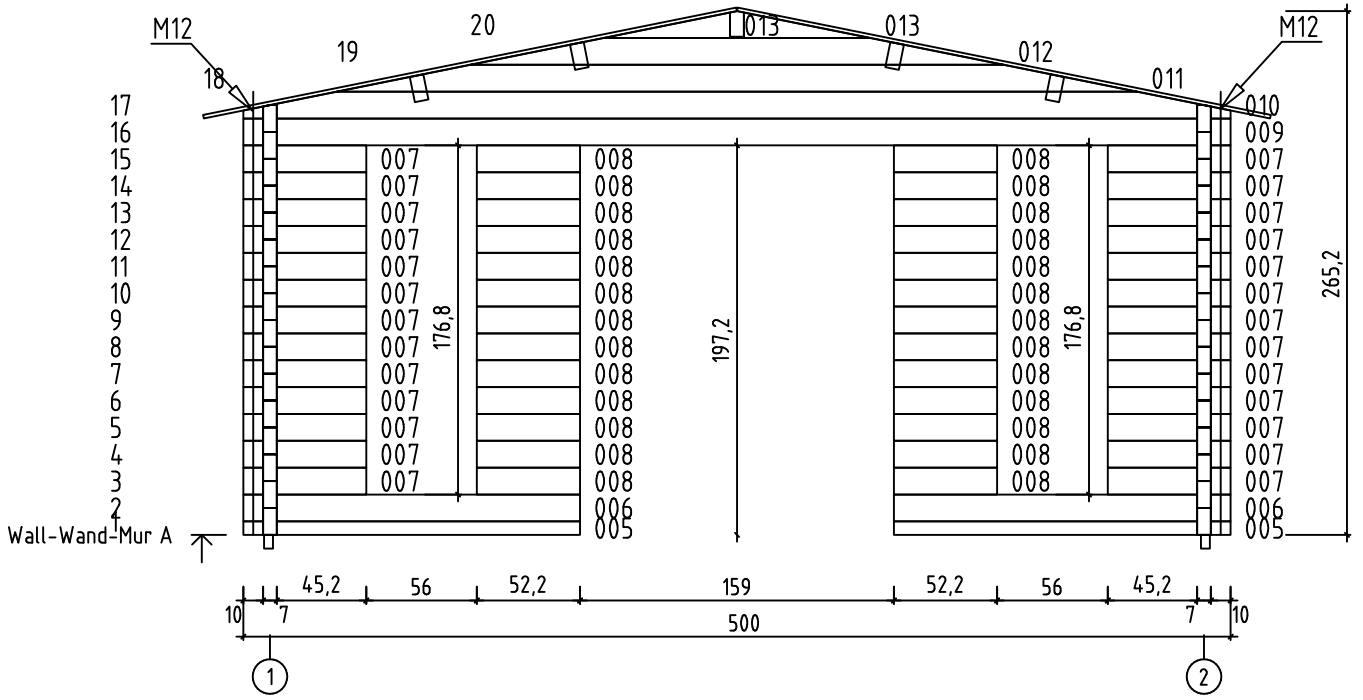

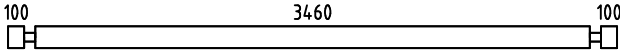
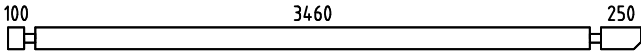
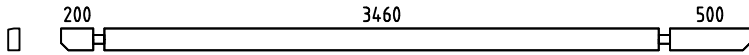
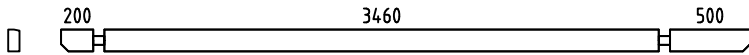
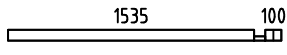
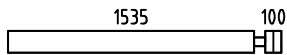
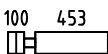

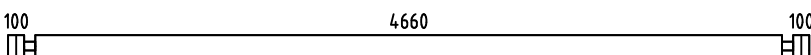
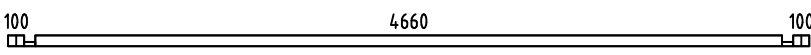
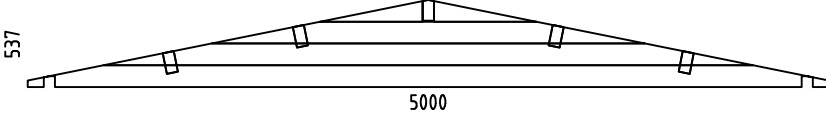
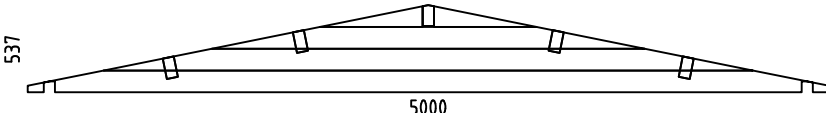
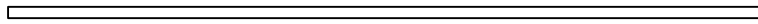
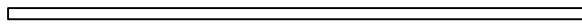
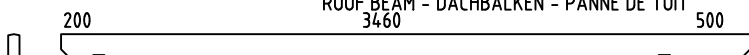
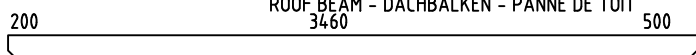



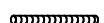







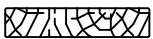

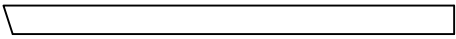





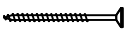
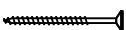

TWO SINGLE WINDOWS HAVE BEEN DELIVERED TOGETHER WITH THE CABIN. YOU CAN CHOOSE THE LOCATION FOR THE WINDOWS BY YOURSELF BY CUTTING THE WALL LOGS AS SHOWN IN THE PICTURE (SEE THE DOTTED LINE)

IM LIEFERUMFANG SIND ZWEI EINZELFENSTER ENTHALTEN. WERKSSEITIG SIND HIERFÜR KEINE AUSSPARUNGEN VORGESEHEN SO DASS SIE DIE EXAKTEN POSITIONEN DER FENSTER SELBST WÄHLEN KÖNNEN. EINE ANLEITUNG HIERFÜR ENTNEHMEN SIE BITTE DER MONTAGEANLEITUNG (SIEHE BILD)

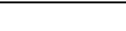
LES DEUX FENÊTRES SONT FOURNIES AVEC CET ABRI DU JARDIN. SELON VOTRE CONVENANCE, VOUS POUVEZ CHOISIR LA POSITION POUR CES FENÊTRES ET COUPER LES MADRIERS COMME MARQUE SUR L'IMAGE.

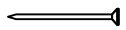

| Pos   | Elgin 70, Art.No.7012902<br>Piece list - Stückliste - Liste des pieces  | Q. | P<br>(mm) | L<br>(mm) |
|-------|---|----|-----------|-----------|
| 001   |    | 28 | 70x136    | 3800      |
| 002   |    | 2  | 70x136    | 3950      |
| 003   |    | 1  | 70x136    | 4300      |
| 004   |    | 1  | 70x136    | 4300      |
| 005   |    | 2  | 70x68     | 1705      |
| 006   |    | 2  | 70x136    | 1705      |
| 007   |    | 26 | 70x136    | 623       |
| 008   |    | 26 | 70x136    | 523       |
| 009   |   | 16 | 70x136    | 5000      |
| 014   |   | 1  | 70x68     | 5000      |
| WA-1  |    | 1  |           |           |
| WB-1  |   | 1  |           |           |
| IAR1  | FOUNDATION - FUNDAMENT - FONDATION<br>  | 9  | 45x70     | 4700      |
| IAR2  | FOUNDATION - FUNDAMENT - FONDATION<br>   | 2  | 45x70     | 3590      |
| PR1   | ROOF BEAM - DACHBALKEN - PANNE DE TOIT<br>   | 1  | 70x140    | 4300      |
| A-PR1 | ROOF BEAM - DACHBALKEN - PANNE DE TOIT<br>   | 4  | 70x140    | 4300      |
|       | FLOOR BOARDS - FUSSBODENBRETTER - LAME DE PLANCHER<br>                               | 52 | 90x18     | 3456      |
|       | ROOF BOARDS - DACHBRETTER - VOLIGES<br>  | 96 | 90x18     | 2754      |
|       | FLOOR FILLET-FUSSBODENLEISTE - CORNIERE DE FINITION DU PLANCHER<br>                  |    | 15x40     | 16.2 m.   |
| DPL   | ROOFING FELT FILLET - DACHPAPPENLEISTE - BAGUETTE DE FIXATION DU FEUTRE BITUMEUX<br> | 4  | 18x58     | 2804      |
| M12   | TREADED ROD M12 - GEWINDESTANGE M12 - TIGE FILETÉE M12<br>                           | 4  |           | 190       |
| M12   | TREADED ROD M12 - GEWINDESTANGE M12<br>TIGE FILETÉE M12<br>                           | 4  |           | 2000      |
| LPL   | FIXING FILLET - FIXIRUNGSLEISTE - PROFIL DE FIXATION<br>                             | 8  | 20x70     | 512       |

| Pos  | Elgin 70, Art.No.7012902<br>Piece list - Stückliste - Liste des pieces   |   | Q.  | P<br>(mm) | L<br>(mm) |
|------|--|---|-----|-----------|-----------|
| LPL  | FIXING FILLET - FIXIRUNGSLEISTE - PROFIL DE FIXATION   |    | 1   | 20x70     | 1540      |
| LPL  | FIXING FILLET - FIXIRUNGSLEISTE - PROFIL DE FIXATION   |    | 8   | 20x70     | 1729      |
| LPL  | FIXING FILLET - FIXIRUNGSLEISTE - PROFIL DE FIXATION   |    | 2   | 20x70     | 1933      |
| TB   | EAVES BOARD - TRAUFBRETT - BANDEAU DE TOIT   |    | 2   | 18x90     | 4300      |
| DRV  | ROOF EDGE REINFORCEMENT - DACHRANDVERSTÄRKUNG - CORNIERE DE RENFORT DE BORD DE TOIT                                |    | 2   | 28x34     | 4300      |
| GL   | GABLE MOULDING - GIEBELLEISTE - PLANCHE DE RIVE  |     | 4   | 18x120    | 2804      |
| KL4  | LENGTHENING BOLT FOR TREADED ROD - VERLÄNGERUNGSMUTTER FÜR GEWINDESTANGE - MANCHON DE RACCORDEMENT DE TIGE FILETÉE |    | 4   |           |           |
| KL1  | DRIVE NUT TREADED ROD - EINSHLAGMUTTER FÜR GEWINDESTANGE - ÉCROU A FRAPPER POUR TIGE FILITÉE                       |    | 4   |           |           |
| KL2  | NUT FOR TREADED ROD - MUTTER FÜR GEWINDESTANGE - ÉCROU POUR TIGE FILETÉE   |    | 4   |           |           |
| KL3  | PLAIN WASHER TREADED ROD - UNTERLEGSSCHEIBE FÜR GEWINDESTANGE - RONDELLE PLATE POUR TIGE FILETÉE                   |    | 4   |           |           |
| HS12 | SCREW FOR GABLE SEGMENT - SCHRAUBEN FÜR DECKBLATT - VIS POUR FIXATION LOSANGE DE FINITION                          |   | 4   | 3.5x35    |           |
| HS83 | SCREW FOR FIXING FILLET - SCHRAUBEN FÜR FIXIRUNGSLEISTE - VIS POUR PROFIL DE FIXATION                              |  | 87  | 3.5x50    |           |
| HS16 | SCREW FOR GABLE MOULDING - SCHRAUBEN FÜR GIEBELLEISTE - VIS DE FIXATION POUR PLANCHE DE RIVE                       |  | 32  | 3.5x50    |           |
| HS32 | SCREW FOR EAVES BOARDS - SCHRAUBEN FÜR TRAUFBRETT - VIS DE FIXATION POUR BANDEAU DE TOIT                           |  | 20  | 4x40      |           |
| HS26 | SCREW FOR ROOF EDGE REINFORCEMENT - SCHRAUBEN FÜR DACHRANDVERSTÄRKUNG - VIS POUR RENFORT DE BORD DE TOIT           |  | 20  | 4x40      |           |
| HS40 | SCREW FOR 1. WALL BEAM - SCHRAUBE FÜR 1. BOHLENREIHE - VIS DE FIXATION DES FONDATIONS                              |  | 8   | 5x120     |           |
| HS42 | SCREW FOR GABLE - SCHRAUBEN FÜR GIEBEL - VIS POUR FIXATION DES PIGNONS   |  | 8   | 5x120     |           |
| HS43 | SCREW FOR ROOF BEAMS - SCHRAUBEN FÜR DACHBALKEN - VIS POUR PANNE DE TOIT   |  | 10  | 5x120     |           |
| HS39 | SCREW FOR FUNDAMENT - SCHRAUBEN ZUR BEFESTIGUNG FUNDAMENT - VIS POUR FONDATION                                     |  | 40  | 5x90      |           |
| MS   | SCREW FOR DOORSTEP - SCHRAUBEN FÜR TÜRSCHWELLE - VIS DE FIXATION DU SEUIL DE PORTE                                 |  | 3   | 4.5x65    |           |
| SH70 | HAMMER BLOCK - SCHLAGHOLZ - CALLE DE FRAPPE  |  | 1   |           |           |
| NFD  | ZN NAIL FOR ROOFING FELT FILLET - ZN NÄGEL FÜR DACHPAPPENLEISTE - POINTE POUR BAGUETTE FIXATION FEUTRE BITUMEUX    |  | 24  | 2x40      |           |
| NFF  | ZN NAIL FOR FLOOR FILLETS - ZN NÄGEL FÜR FUSSBODENLEISTEN - POINTE POUR PANNEAUX DE PLANCHER                       |  | 33  | 1.4x40    |           |
| NF2  | ZN NAIL FOR ROOF - ZN NÄGEL FÜR DACHBRETT - POINTE POUR TOIT   |  | 410 | 2x50      |           |
| NH1  | ZN NAIL FOR FLOOR - ZN NÄGEL FÜR FUSSBODENBRETT - CLOUS POUR PLANCHER  |  | 380 | 2x50      |           |

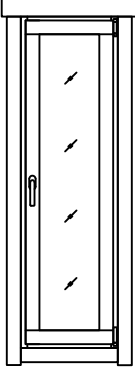
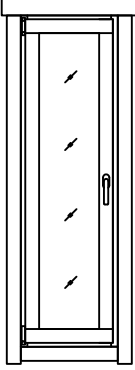
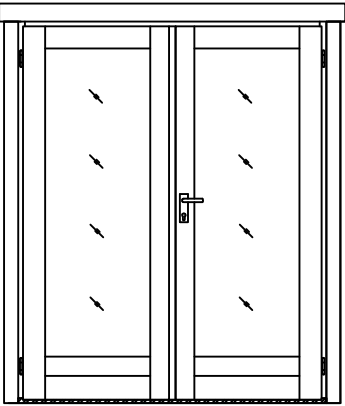

| Pos           | Elgin 70, Art.No.7012902<br>Piece list - Stückliste - Liste des pieces  | Q. | P<br>(mm) | L<br>(mm) |
|---------------|---|----|-----------|-----------|
| ORZ           | MONTAGE SET FOR DOORS AND WINDOWS - MONTAGE-SET FÜR TÜREN UND FENSTER - JEU DE MONTAGE PORTES ET FENETRES                         | 1  |           |           |
| GS            | GABLE SEGMENT-DECKBLATT - LOSANGE DE FINITION  | 2  |           |           |
| 3+ A<br>.0P.b | WINDOW-FENSTER-FENETRE 552x1729<br>              | 2  |           |           |
| 3+ A<br>.0V.b | WINDOW-FENSTER-FENETRE 552x1729<br>             | 2  |           |           |
| 2+ T<br>U.10P | DOOR-TÜR-PORTE 1580x1933<br>                   | 1  |           |           |
|               |   |    |           |           |
|               |   |    |           |           |
|               |   |    |           |           |
|               |   |    |           |           |
|               |   |    |           |           |



## GU Hinweise auf Gefahren, Unterlassungen und Bedienung

Um Schäden am Fenster zu vermeiden, ist folgendes zu beachten:

- Flügel nicht zusätzlich belasten,
- Flügel nicht gegen die Leibung überdrehen,
- keine Gegenstände zwischen Rahmen und Flügel klemmen.

Um Unfälle zu vermeiden wird auf folgende Gefahren hingewiesen:

- Die Verletzungsgefahr durch Einklemmen im Spalt zwischen Rahmen und Flügel,
- die Absturzgefahr am geöffneten Fenster,
- Verletzungen durch Windstoß in Drehstellung.

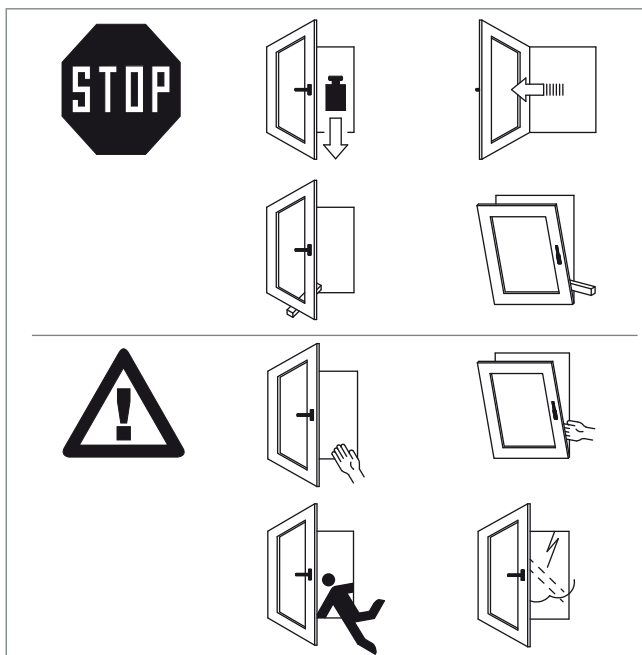

Drehkipfenster bedienen  
(Bedeutung der Symbole)

- grün: Flügel geschlossen
- blau: Flügel in Kippstellung zum Lüften
- rot: Flügel in Drehstellung zum Reinigen und zur Stoßlüftung

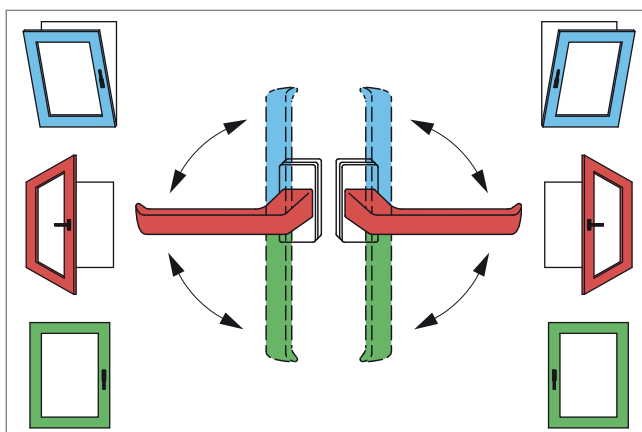

### Achtung:

Um Gefahren zu vermeiden, müssen Fensterflügel in Drehstellung gehalten oder fixiert werden.

### Gewährleistung erhalten!

Hinweise zur Pflege und Wartung bzw. Vermeidung von Schäden und Unfällen sowie zur Bedienung, sind zur Aufrechterhaltung der Gewährleistung unbedingt zu beachten und zu befolgen.

Bedienungs-Aufkleber bei Bedarf bitte anfordern.

## GU Fenster richtig pflegen, warten und bedienen



Adresse / Ihr Fensterservice:

Sie haben Fenster mit hochwertigen Drehkippschlägen von Gretsch-Unitas in Benutzung genommen. Jedes Fenster unterliegt – wie andere Bauteile auch – einer normalen Abnutzung. Die Leichtgängigkeit des Fensterbeschläges sowie die Lebensdauer Ihrer Fenster hängt im wesentlichen von deren Pflege ab. Vom Benutzer sind an Fenstern und Fenstertüren mindestens einmal jährlich folgende Wartungsarbeiten durchzuführen:

- ☾ Alle beweglichen Teile und alle Verschlussstellen der Beschläge sind zu fetten und auf Funktion zu prüfen.
- + Die Befestigungsschrauben des Fenstergriffes sind nachzuziehen (Griffrosette vorsichtig lösen).

**Wir empfehlen Ihnen den Abschluss eines Wartungsvertrages**

Bei auftretenden Störungen, die eine sichere Funktion des Fensters nicht mehr gewährleistet, verständigen Sie gleich Ihren Fensterfachmann.

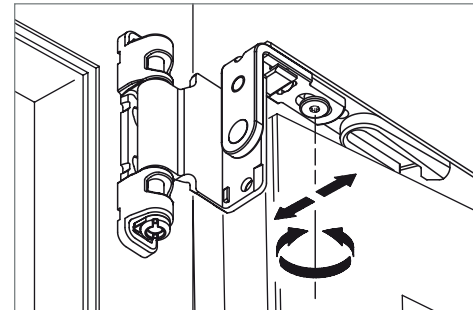

Flügelanddruck einstellen

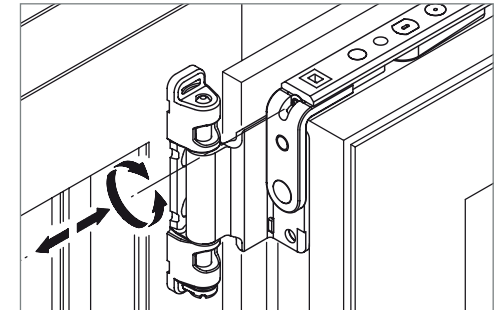

Seitliche Flügeleinstellung – Schere

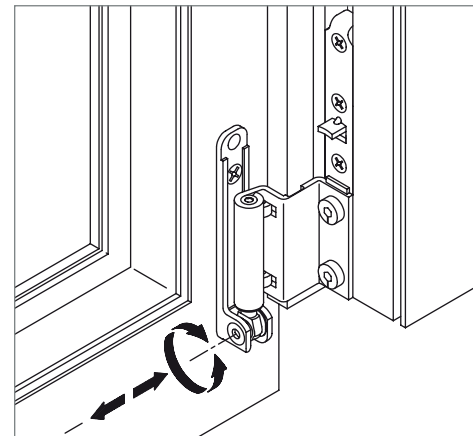

Seitliche Flügeleinstellung – Ecklager

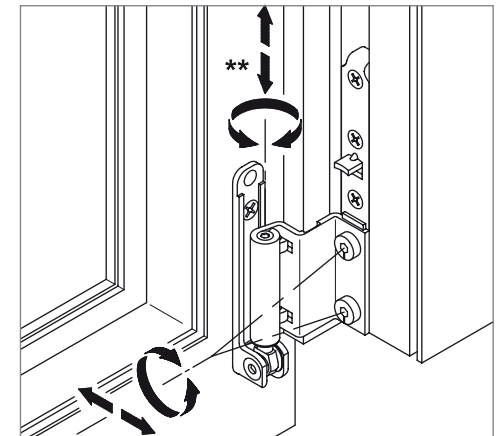

Flügel anheben, Andruck einstellen

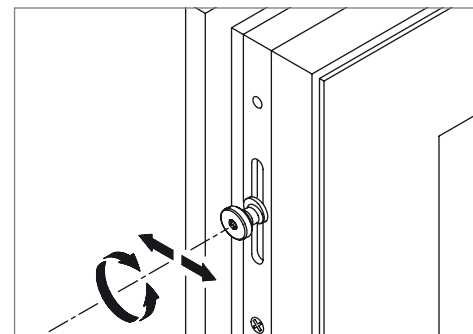

Flügelanddruck regulieren

Wir empfehlen, die Fensteroberfläche und die Verglasung regelmäßig zu überprüfen und Schäden auszubessern.

Die Fenster-Dichtung darf nicht gestrichen und nicht lackiert werden.

**Bei Bedarf übernimmt Ihr Fensterhersteller die Flügeleinstellung! \***

(\*) Einstellwerkzeug = Torx 15 Schraubendreher bzw. Sechskantschlüssel SW 4 (\*\*)



## Mise en garde des mauvaises utilisations

Consignes à respecter afin de préserver le bon fonctionnement de la fenêtre:

- Ne pas surcharger le vantail,
- Ne pas forcer l'ouverture du vantail contre l'ébrasement,
- Ne pas coincer d'objet entre l'ouvrant et le dormant.

Mise en garde des dangers:

- Risque de blessures par pincement entre ouvrant et dormant, vantail entre ouvert,
- Risque de chute par fenêtre ouverte,
- Blessures par coup de vent en rafale en position ouvrant à la française.

Utilisation de fenêtre oscillo-battante (Signification des symboles)

- vert: Vantail fermé
- bleu: Vantail en position soufflet (aération)
- rouge: Vantail en position ouvrant à la française ou de nettoyage

### Attention:

Pour éviter les dangers il faut tenir ou bloquer une fenêtre lorsqu'elle est ouverte.

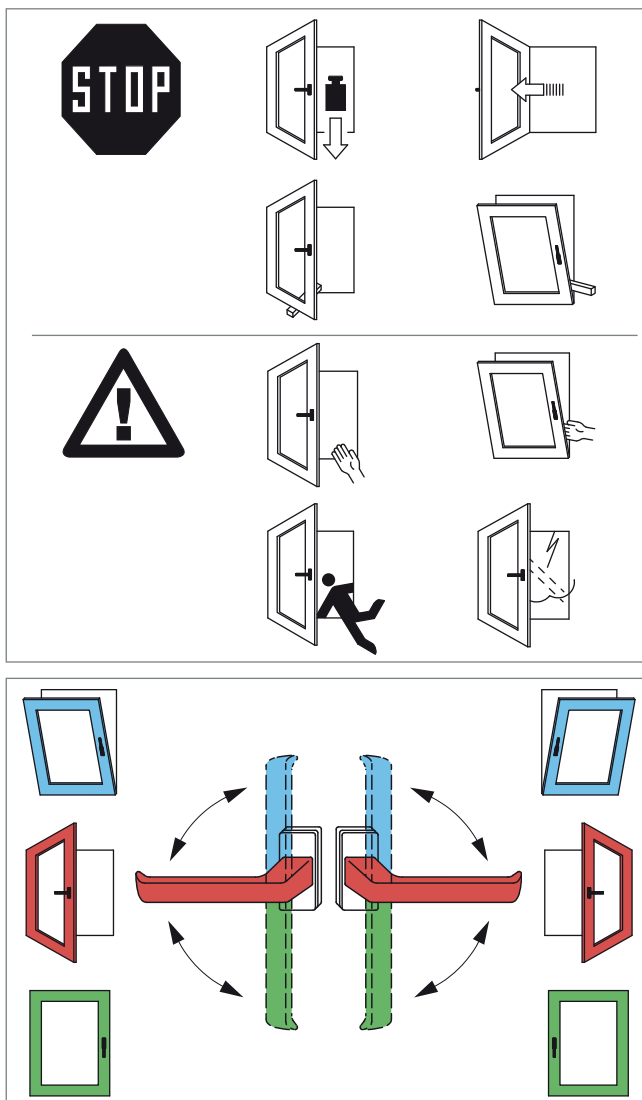

### Conservation de garantie!

Les conseils d'entretien, de bon fonctionnement et de mise en garde des mauvaises utilisations sont impérativement à respecter afin de conserver la garantie de la fenêtre.

Au besoin veuillez demander un autocollant d'utilisation.



## Bien utiliser, prendre soin et savoir entretenir une fenêtre



Adresse / Votre service fenêtre:

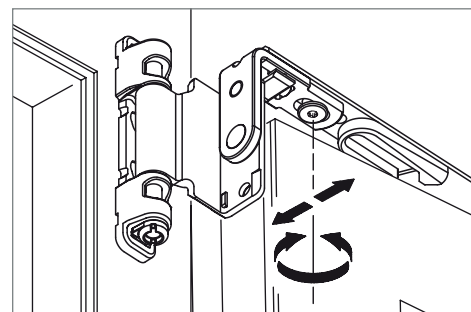
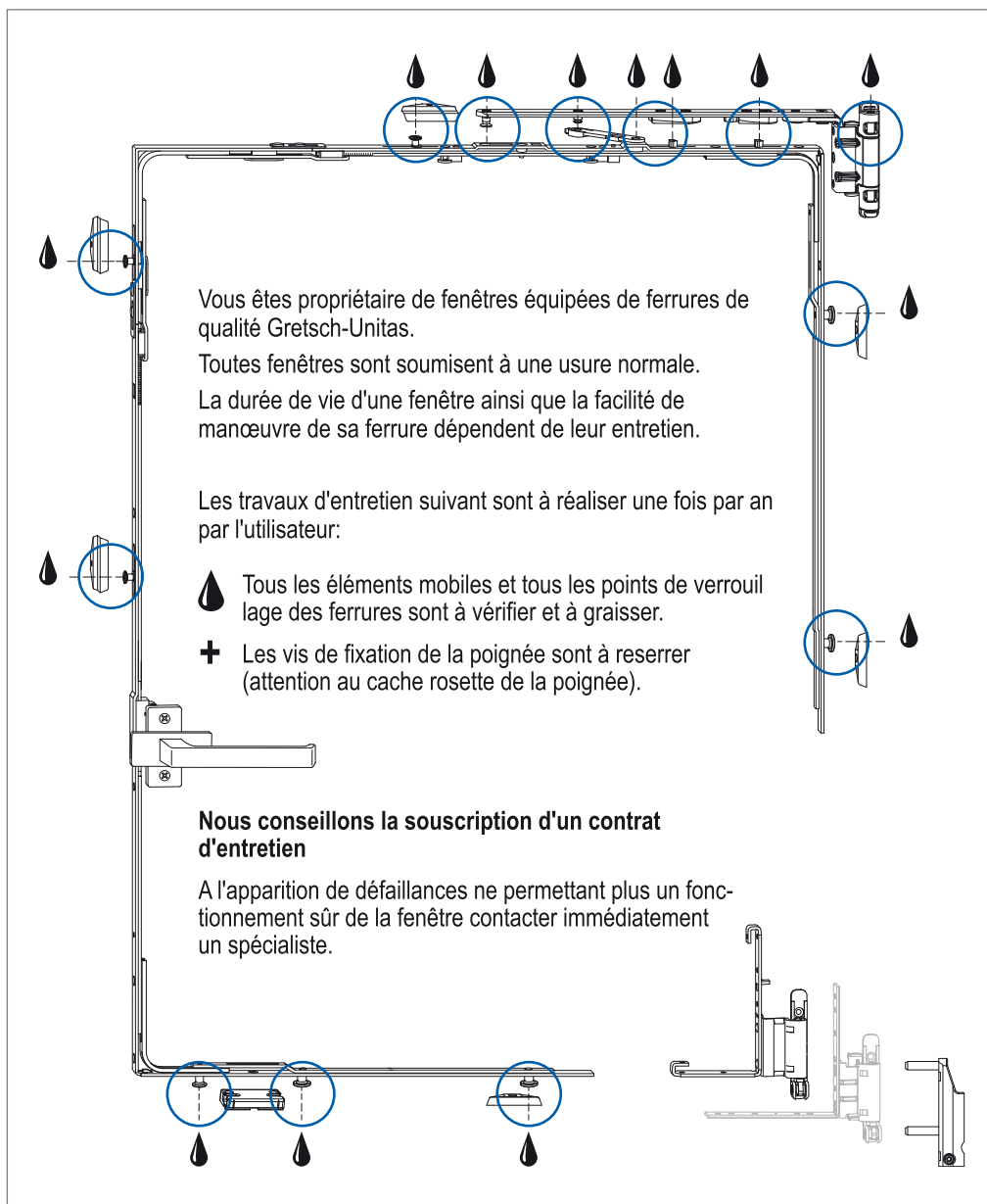

Ajustement de la compression du vantail

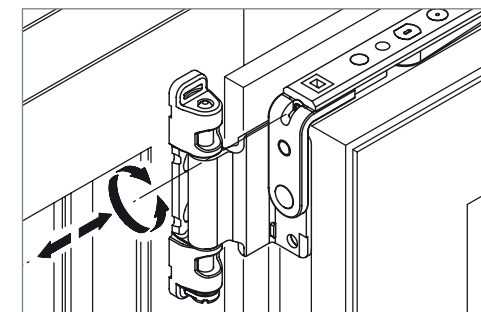

Ajustement latéral du vantail – Compas

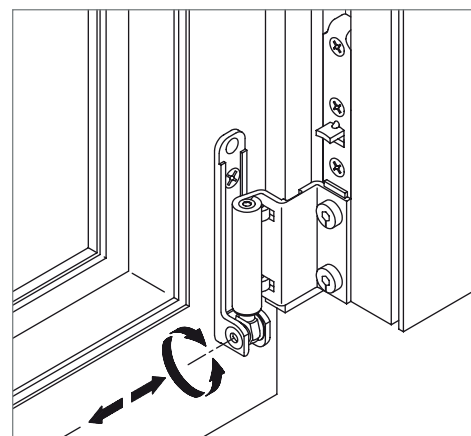

Ajustement latéral du vantail – Support d'angle

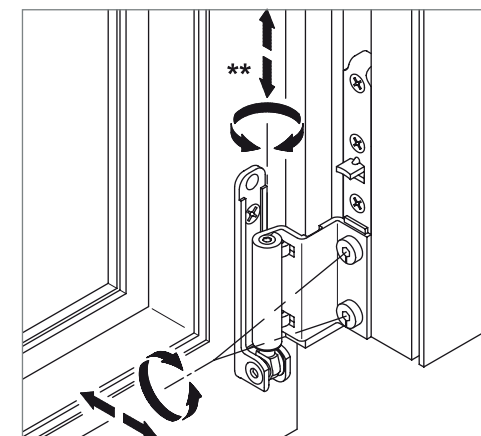

Réglage en hauteur du vantail, réglage en compression

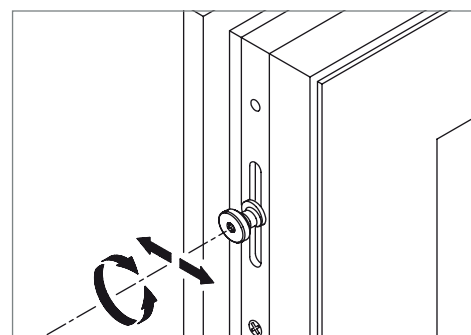

Réglage de la compression du vantail

Nous vous conseillons de vérifier régulièrement l'état de la fenêtre et du vitrage, et de réparer les défauts.

Les joints de fenêtre ne ni à peindre ni à lasurer.

**Le réglage des vantaux peut être fait par votre fabricant de fenêtres! \***

(\*) Outil de réglage = Tournevis Torx 15 ou clé Allen taille 4 (\*\*)





## Advice on operation, default and hazards

In order to avoid damage to your window take note of the following advice :

- Do not put any load on the sash
- Do not turn the sash beyond the predetermined opening angle
- Do not jam the sash by placing an object between sash and frame

In order to prevent accidents be aware of the following hazards :

- Risk of getting crushed between frame and sash
- Risk of falling out of the open window
- Risk of injury by sash swinging open through a gust of wind

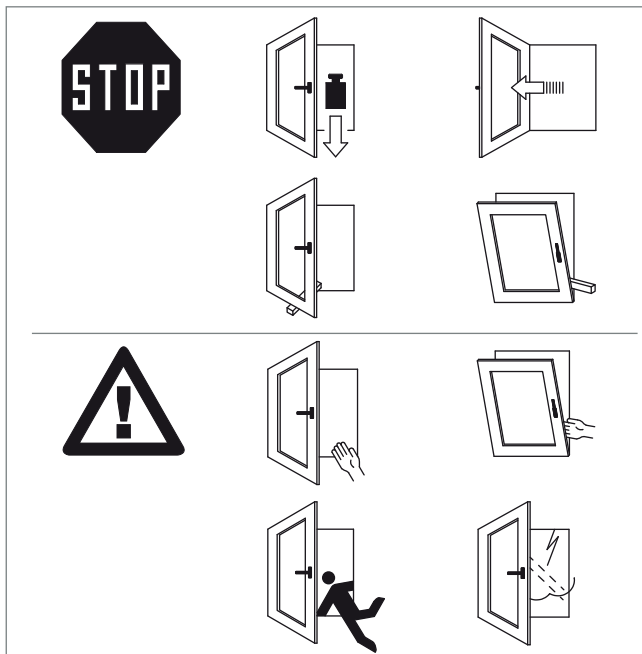

How to operate a tilt-turn window :  
(meaning of symbols)

- green: sash closed
- blue: sash in tilt position for airing
- red: sash in turn position for cleaning or inrush airing

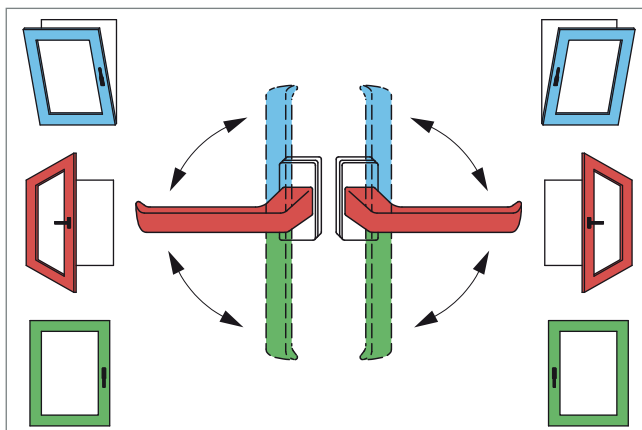

### Attention:

In order to prevent hazards it is necessary that sashes in turn position should be held or secured.

### Maintain your window's warranty !

In order to maintain the warranty on the window hardware it is imperative that the advice on operation, default and hazards be observed.



## Appropriate operation, maintenance and care of windows



Address / Your maintenance service :



You have acquired a window with highest quality tilt-turn fittings made by Gretsch-Unitas.

Every window – as other building elements also – is subject to normal wear.

The smooth and easy movement of the window fittings and also the service life of your window largely depends on the nature of its care.

At least once a year, the user must carry out the following maintenance jobs on windows and patio doors:

- ☾ Grease all moving parts and locking points and verify their proper function.
- + Retighten the fixing screws of the handle (remove handle rosette carefully).

**We recommend to conclude a service contract.**

When problems appear such that a safe function of the window is no longer guaranteed, please call in your window specialist without delay.

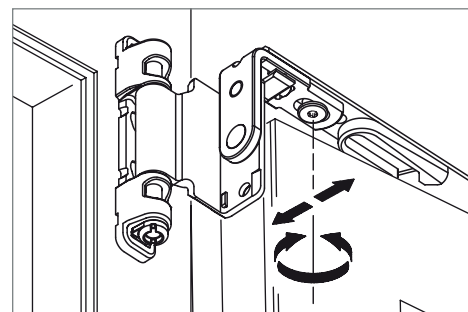

Gasket pressure adjustment – stay arm

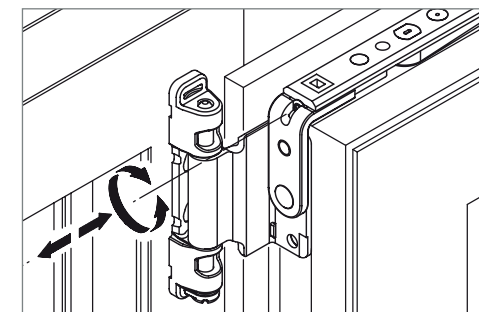

Horizontal sash adjustment – stay arm

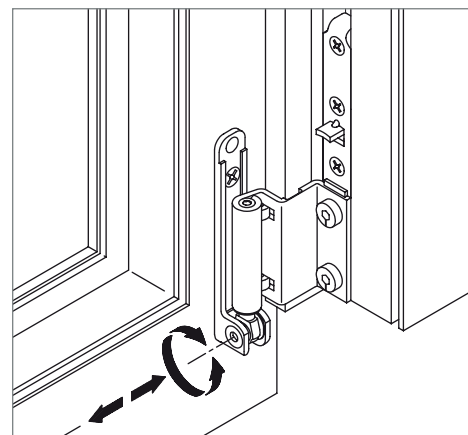

Horizontal sash adjustment – corner bearing

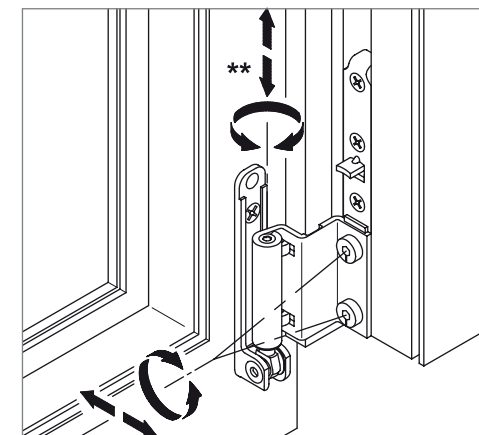

Vertical and gasket pressure adjustment

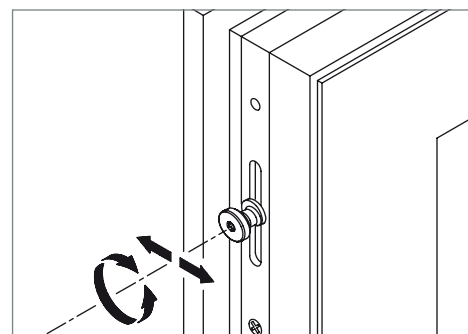

Gasket pressure adjustment – mushroom pin

We recommend that the window finish and glazing be regularly checked over and any damage made good.

The gasket must not be painted over or cleaned with aggressive agents.

**If necessary, ask your window fabricator to undertake the adjustments! \***

(\*) Adjustment tool: Torx 15 screwdriver or Allen key size 4 (\*\*)



## **GU** Aanwijzingen voor gevaar, foutief gebruik en bediening

Om schade aan het raam te voorkomen moet het volgende in acht genomen worden:

- Het raam niet extra belasten.
- Het raam niet tegen de negge drukken.
- Geen voorwerpen tussen het raam en kozijn klemmen.

Om ongevallen te vermijden willen wij U op de volgende gevaren wijzen:

- Verwonding door inklemming tussen raam en kozijn.
- Het gevaar om uit een geopend raam te vallen.
- Verwonding door winddruk in de draaistand.

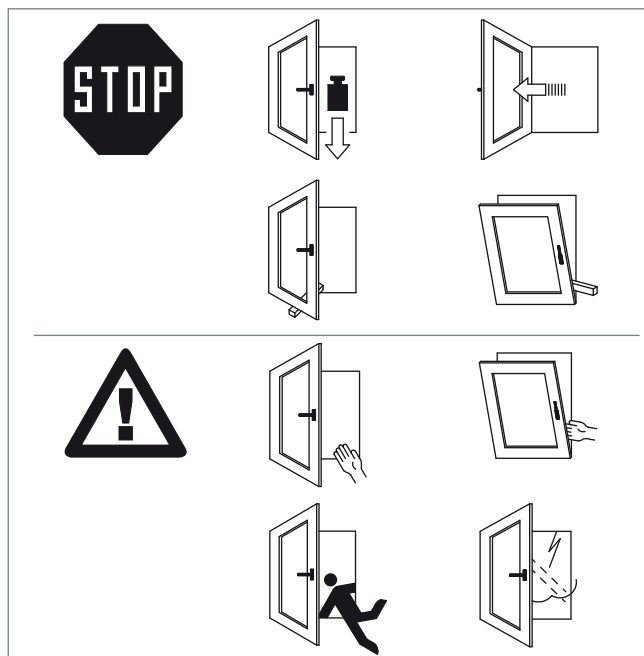

Draaivalraam bedienen  
(verklaring van de symbolen)

- Groen: Raam gesloten.
- Blauw: Raam in de valstand om te ventileren.
- Rood: Raam in de draaistand om te reinigen of te luchten.

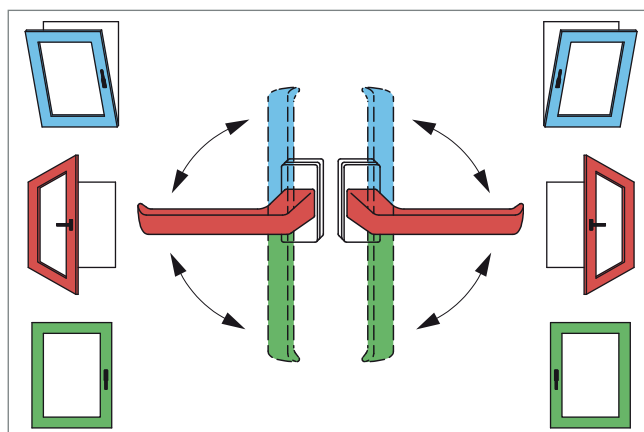

### Let op:

Om gevaar te vermijden, moet het raam in de draaistand altijd vastgehouden of gefixeerd worden.

### Garantievoorwaarden!

Onderhoud en nastellen van het beslag en het op de juiste manier bedienen en gebruiken zijn voorwaarden om aanspraak op garantie te kunnen maken.

Bedieningssticker is indien gewenst leverbaar.

## **GU** Het raam goed reinigen, onderhouden en bedienen



Adres / Serviceadres:



Met de aanschaf van G.U-Draaivalbeslag heeft U zonder meer een goede keus gemaakt. Het betreft hier immers beslag van hoogwaardige kwaliteit, vervaardigd door een algemeen erkende specialist op dit gebied!

Bij normaal gebruik en de gangbare toepassingen, zal dit beslag dan ook in alle opzichten voortreffelijk voldoen.

Voor een blijvende optimale werking van dit draaivalbeslag en ter bevordering van een extra lange levensduur van het totale raamsysteem, is periodiek onderhoud evenwel ten zeerste aan te bevelen.

Vandaar dat wij U dringend adviseren om tenminste één-maal per jaar het volgende te doen:

- Alle bewegende delen oliën of invetten en op goed functioneren te controleren.
- De beide schroeven van de raamkruk aandraaien.

**Wij raden U aan een onderhoudscontract af te sluiten**

Wanneer onverhoop ernstige storingen optreden, die het functioneren belemmeren, kunt u het beste contact opnemen met uw ramenfabrikant of G.U-dealer.

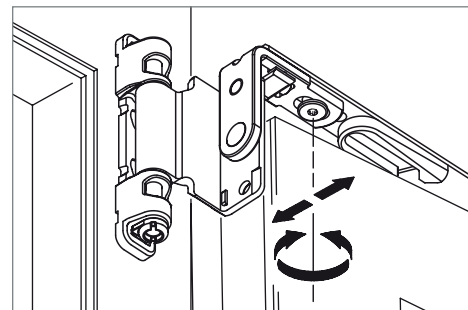

Instellen van de aanpersdruk

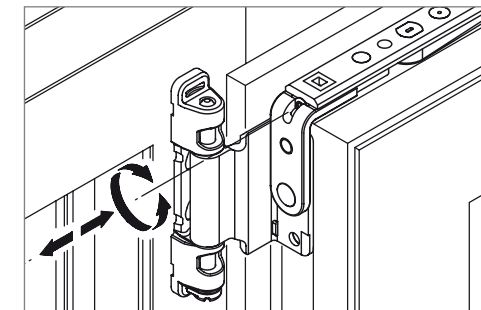

Zijdelings verstellen van de schaar

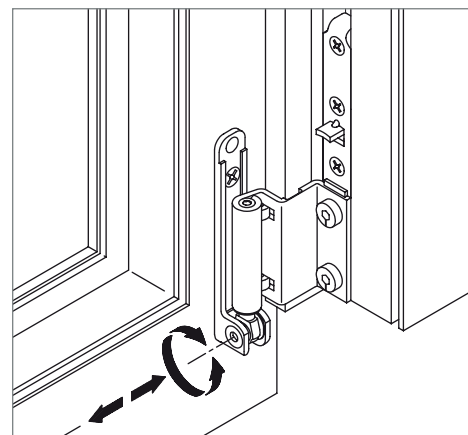

Zijdelingse verstelling speun kozijndeel

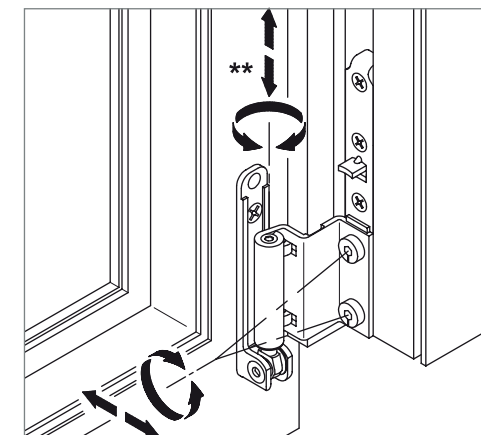

Hoogte verstelling en aanpersdruk

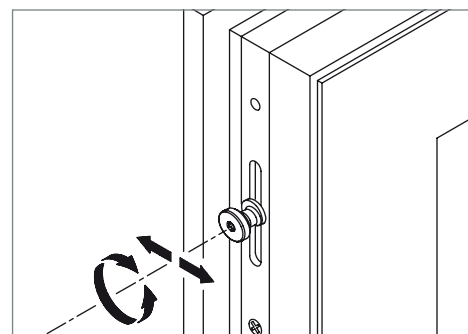

Verstellen van de aanpersdruk

Wij adviseren het raam en de beglazing regelmatig te controleren en eventuele beschadigingen te repareren.

Het beslag en de dichting mogen niet mee geschilderd worden.

**Indien noodzakelijk de ramen laten afstellen door een vakman. \***

(\*) Gereedschap: Torx 15 schroevendraaier respectievelijk inbussleutel 4 (\*\*)

## The programme

- **GU-SECURITY EUROPA MR 2, MR 4**  
(2 or 4 MR bolts): MR/R version also available
- **GU-SECURITY EUROPA SH2**  
(2 SH bolts): SH/R version also available
- **GU-SECURITY EUROPA R 4**  
(4 adjustable roller cams): R 2 and R/P version also available

## System benefits

- Reversible latch: The locks are useable for both DIN left and DIN right
- Extensive range of GU-SECURITY accessories
- Levering the door out is efficiently hampered as the SH bolts hook into the accessories on the frame side
- The adjustable roller cams that come with with the MR/R, SH/R and R 4 versions optimise the door leaf contact pressure in the top and bottom section of the door and ensure a high gasket pressure and tightness

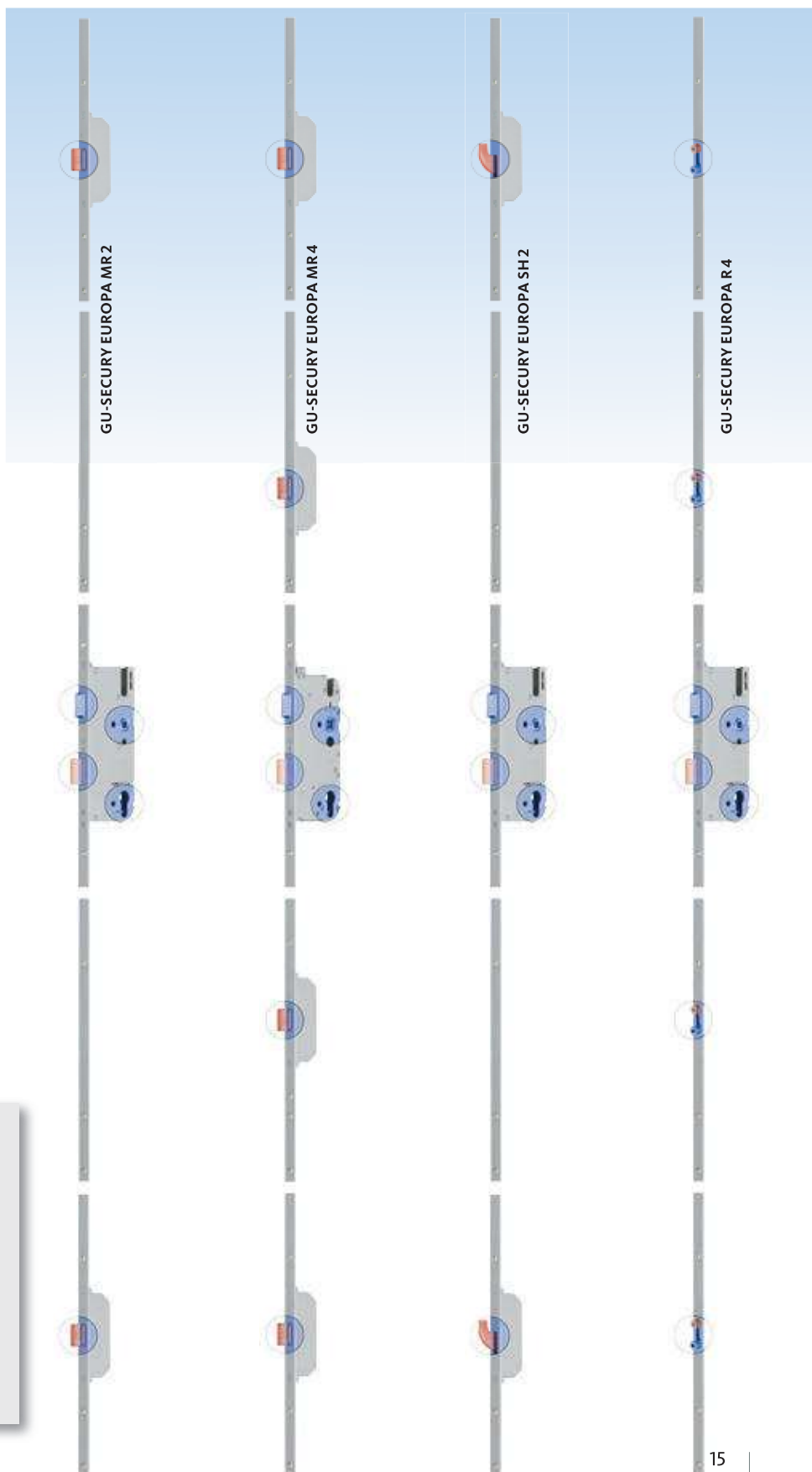

### Handle operation

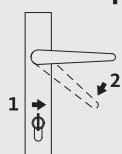

#### Open

1. Release door lock with the key
2. Depress the handle to withdraw the locking points

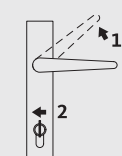

#### Close

1. Lift the handle upwards to engage the locking points
2. Lock with the key

