

Art. Nr. 4018600

1/4

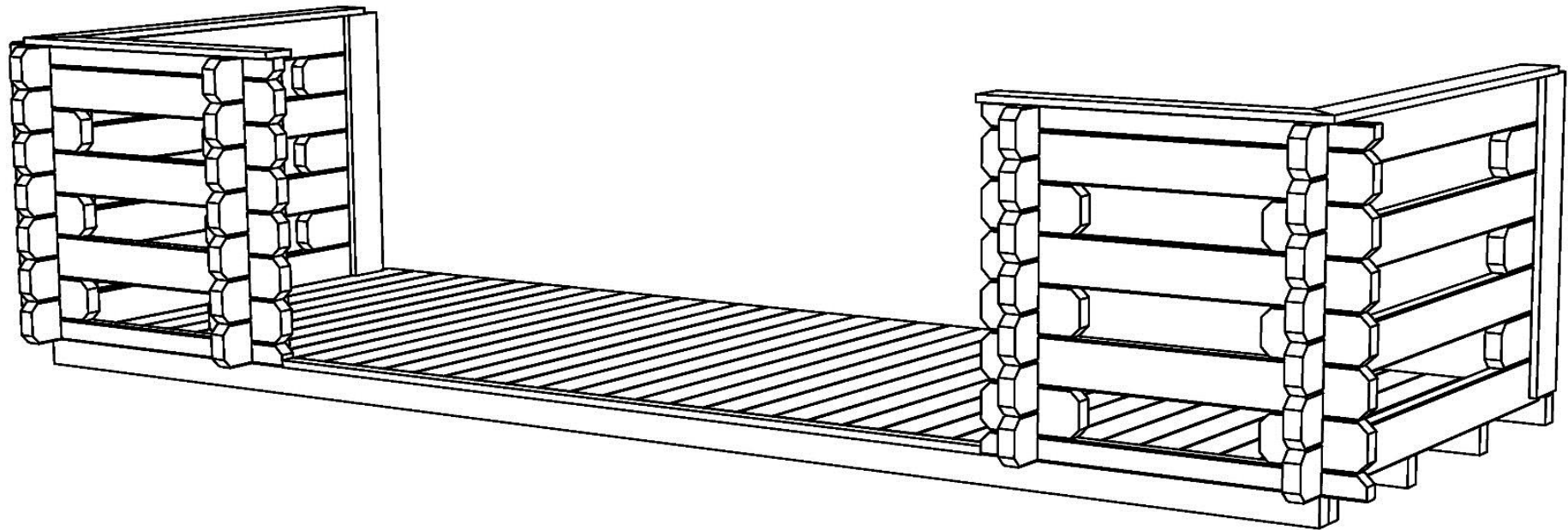

15.05.2018

Art. Nr. 4018600

Groundplan - Grundplan - Plan de masse -
Planimetria - Plattegrond - Põhiplaan

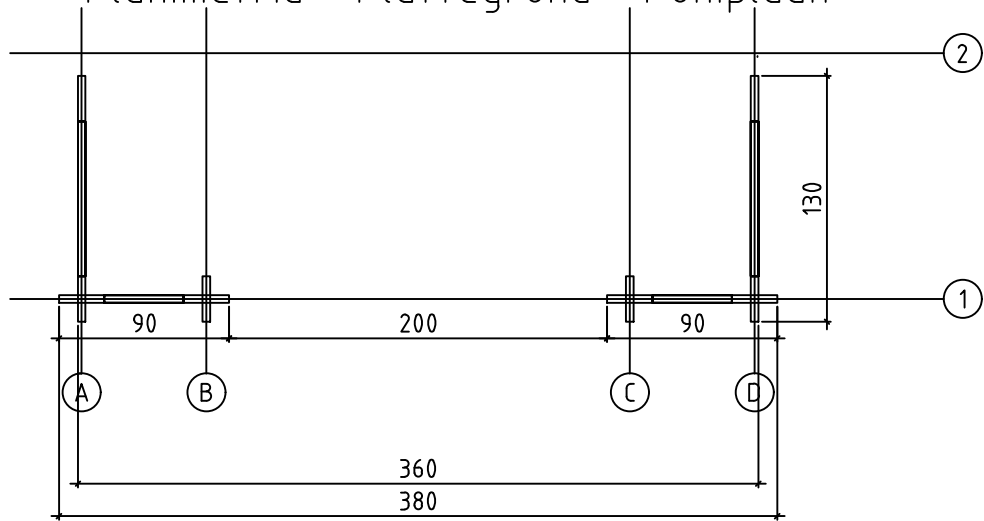

Foundation - Fundament - Fondation -
Fondamenta - Fundering - Immutatud alusraam

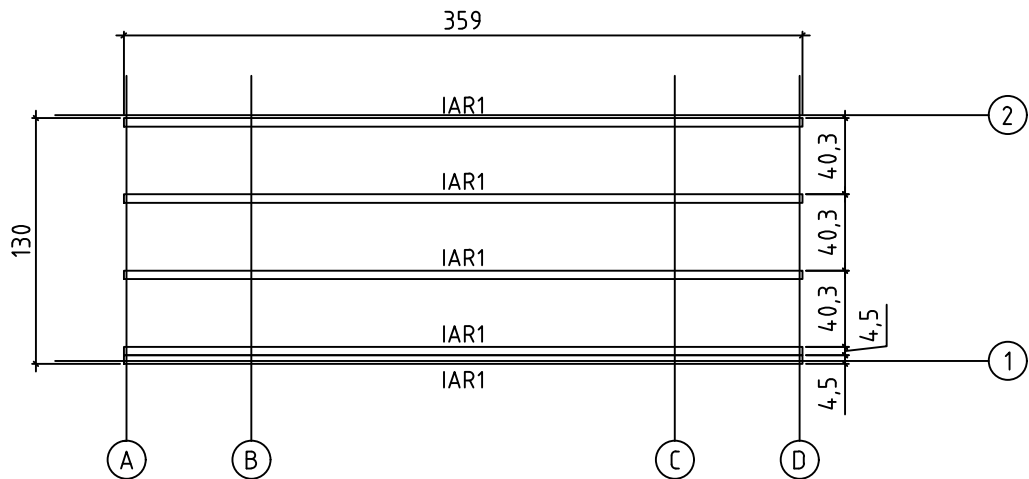



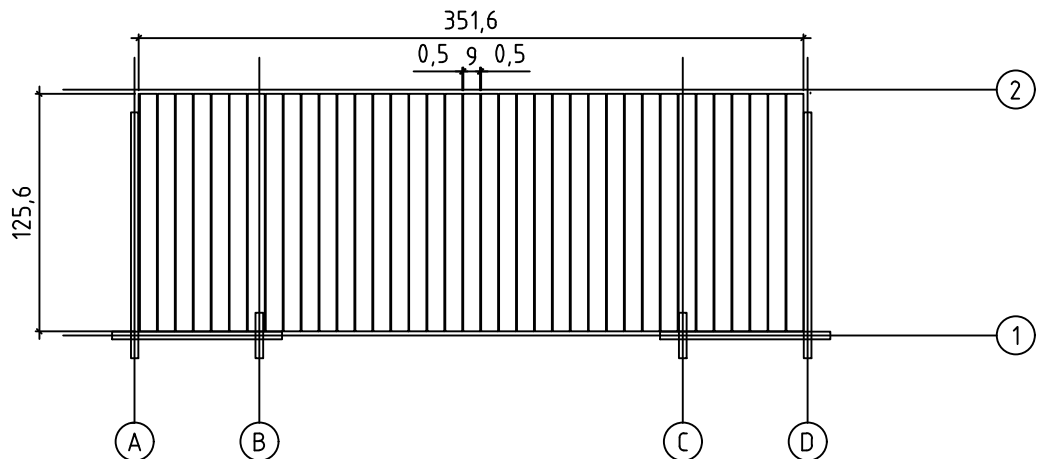



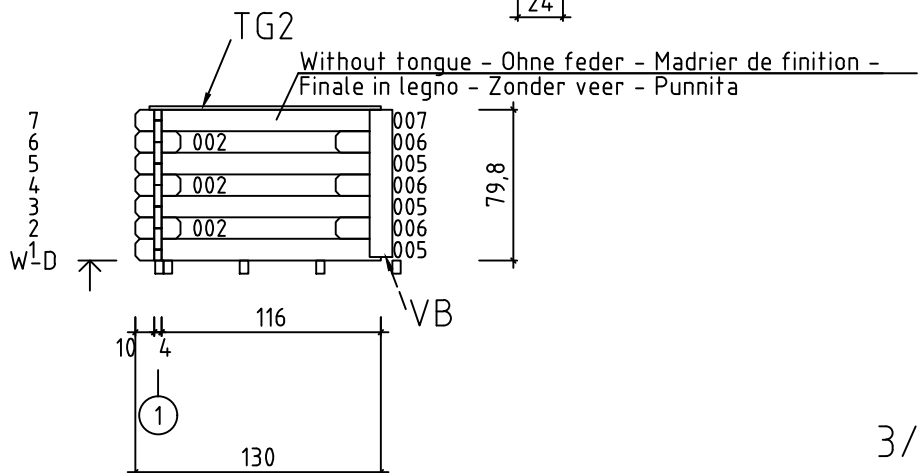
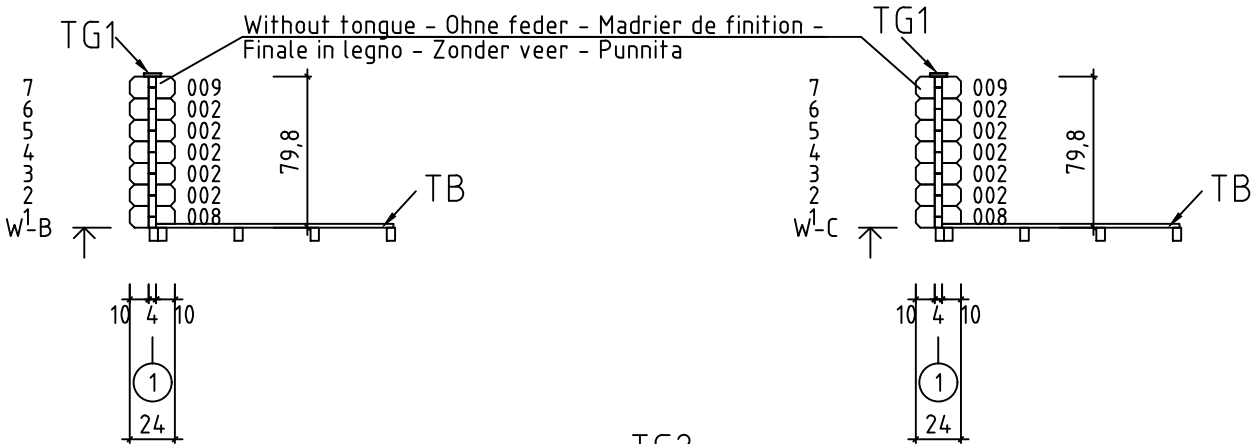
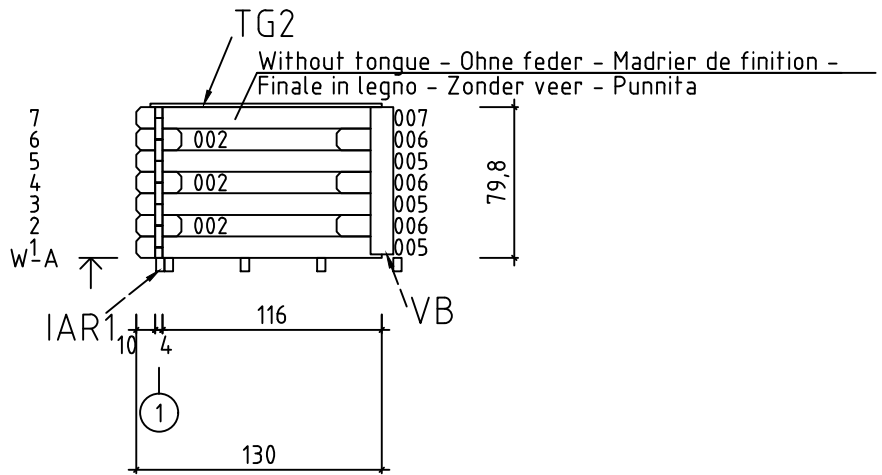
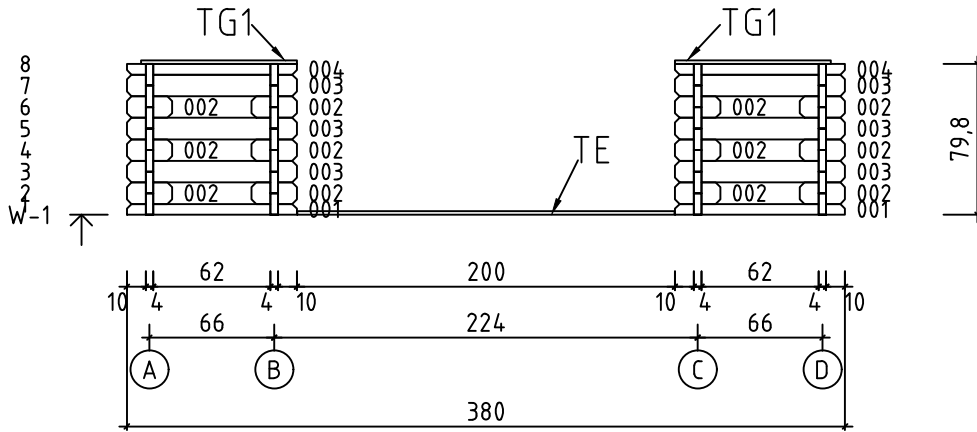

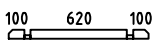

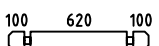
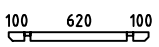
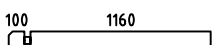

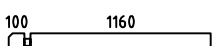



Terrace boards - Terrassenbretter - Plancher de terrasse -
Piattaforme terrazzo - Terrasvloer - Terrassilaudis

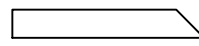
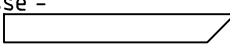
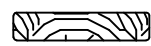

Art. Nr. 4018600

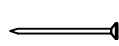
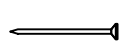

Pos	Piece list - Stückliste - Liste des pièces - Elementi - Stuklijst - Tükítabel 15.05.2018 Art. Nr. 4018600 4/4	Q	P (mm)	L (mm)
001		2	40x57	900
002		28	40x114	240
003		6	40x114	900
004		2	40x57	900
005		6	40x114	1300
006		6	40x114	240
007		2	40x114	1300
008		2	40x114	240
009		2	40x114	240
IAR1	Foundation - Fundament - Fondation - Fondamenta - Fundering - Immutatud alusraam 	5	45x70	3590
TB	Terrace boards - Terrassenbretter - Plancher de terrasse - Piattaforme terrazzo - Terrasvloer - Terrasilaud 	38	90x19	1256
TE	Terrace edge board - Terrassenbrett, eingang - Lamé de seuil d'entree de terrasse - Terrazzo uso abitacolo - Terrasvloer dorpel - Terrassi servaliist 	1	19x40	1998
TG1	Guard-rail for terrace - Terrassengeländer - Main courante de terrasse - Guardrail per terrazzo - Terras leuning - Terrassi äärelaud 	2	18x90	825
TG2	Guard-rail for terrace - Terrassengeländer - Main courante de terrasse - Guardrail per terrazzo - Terras leuning - Terrassi äärelaud 	2	18x90	1225
VB	Terrace joint boards - Verbindungsbrett - Profil de jonction pour fixer la terrasse au mur - Assi del terrazzo che compongono il pavimento - Terras verbindingsplank - Terrassi ühenduslaud 	4	18x120	779
HS9	Screw for terrace joint boards - Schrauben für Verbindungsbrett - Vis de fixation profil de jonction terrasse - Vite per unire delle assi del terrazzo - Schroef voor bevestigen verbindingshout - Kruvi terrassi ühenduseks seinaga 	20	3.5x50	
HS12	Screw for terrace rear boards - Schrauben für Terrassenrand - Vis de fixation pour main courante de terrasse - Vite per il piano posteriore della terrazza - Schroef voor terras afsluitplint (achterzijde) - Kruvi terrassi äärelaudale 	14	4x40	
HS16	Screw for 1. wall beam - Schraube für 1. bohlenreihe - Vis de fixations 1ere rangée de madriers avec poutrelles de fondations - Vite fissaggio alle fondamenta - Schroef voor 1 wandbalk - Kruvi poollaudale 	4	5x90	
HS16	Screw for foundation - Schrauben zur Befestigung Fundament - Vis de fixations des poutrelles de fondations - Viti x fondamenta - Schroef voor fundering - Kruvi alusraamile 	4	5x90	
HS22	Screw for 1. wall beam - Schraube für 1. bohlenreihe - Vis de fixations 1ere rangée de madriers avec poutrelles de fondations - Vite fissaggio alle fondamenta - Schroef voor 1 wandbalk - Kruvi poollaudale 	4	6x150	
NF3	Nail for terrace edge board - Nägel für Terrassenbrett - Clou de fixation de lamé de seuil d'entree de terrasse - Chiodi per unire delle assi del terrazzo - Spijker(nagel) voor terrashout - Nael terrassi servaliistule 	6	2.1x50	
NF3	Zn nail for terrace - Zn nägel für Terrassenbretter - Pointe pour plancher de terrasse - Chiodo zincato per terrazzo - Spijker(nagel) voor terrasvloer - Nael terrasilaudale 	304	2.1x50	