

Internal room kit M
Art. Nr. 9901400
1/17

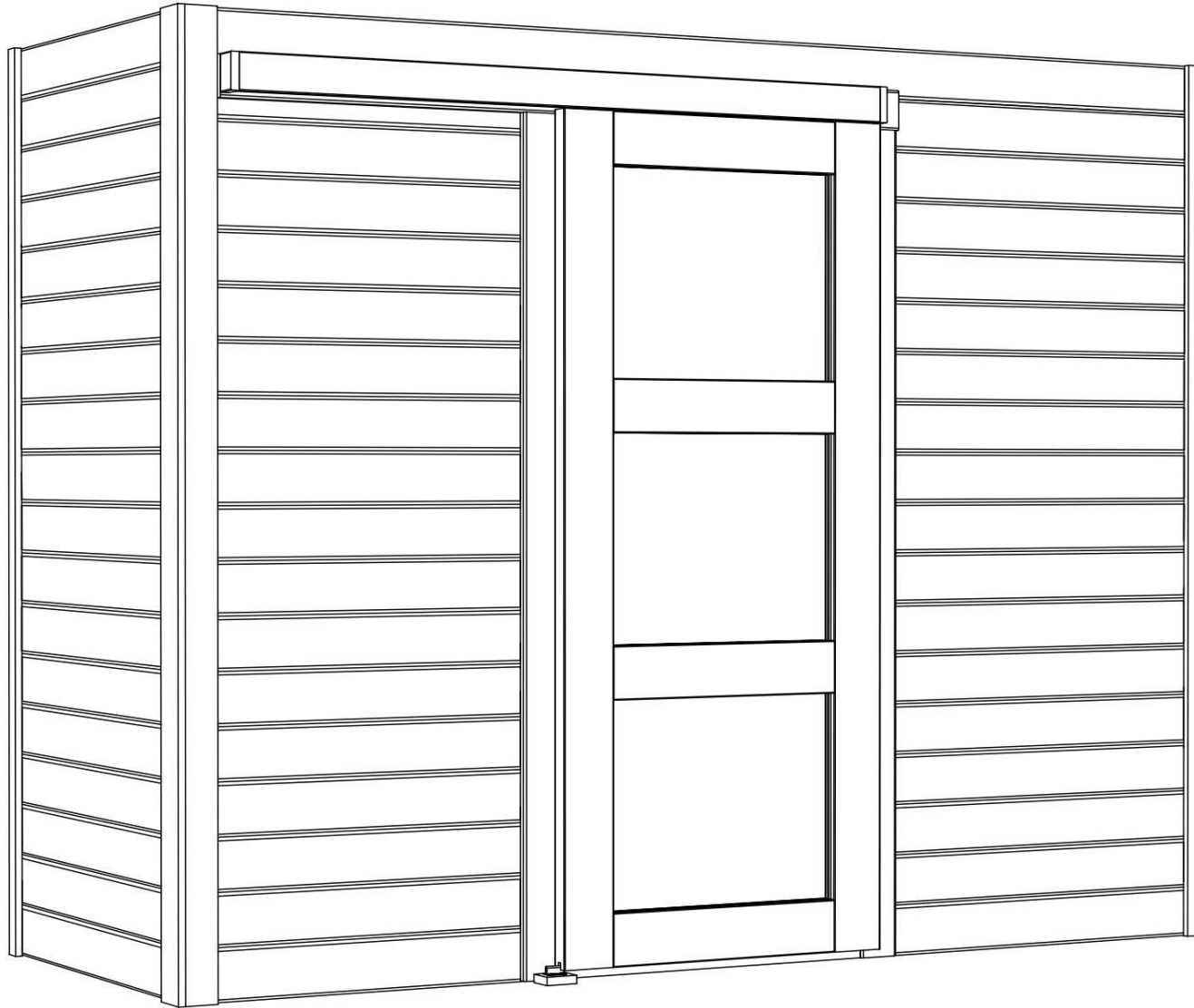

21.01.2020

Art. Nr. 9901400

Groundplan - Grundplan - Plan de masse - Planimetria - Plattegrond - Põhiplaan

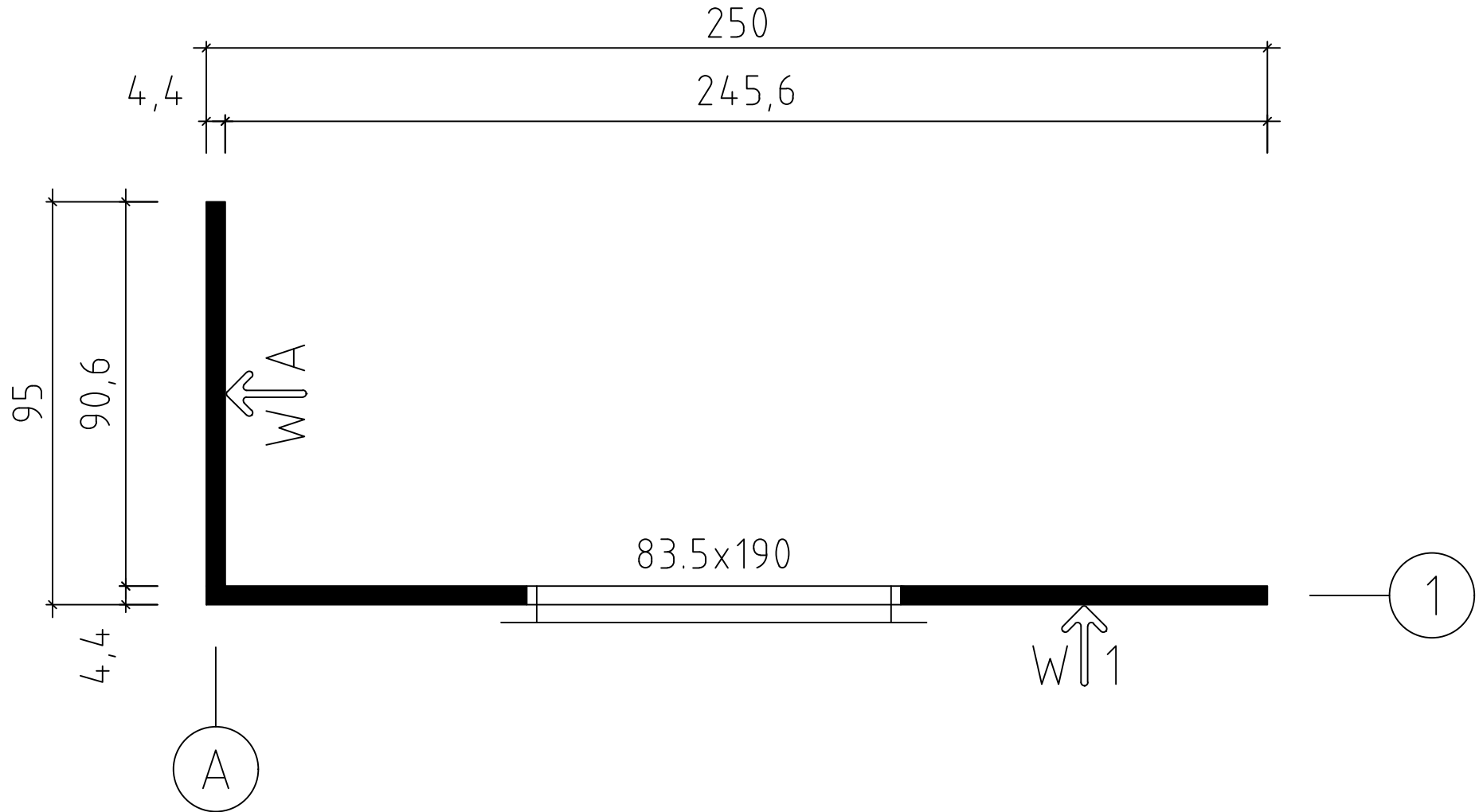





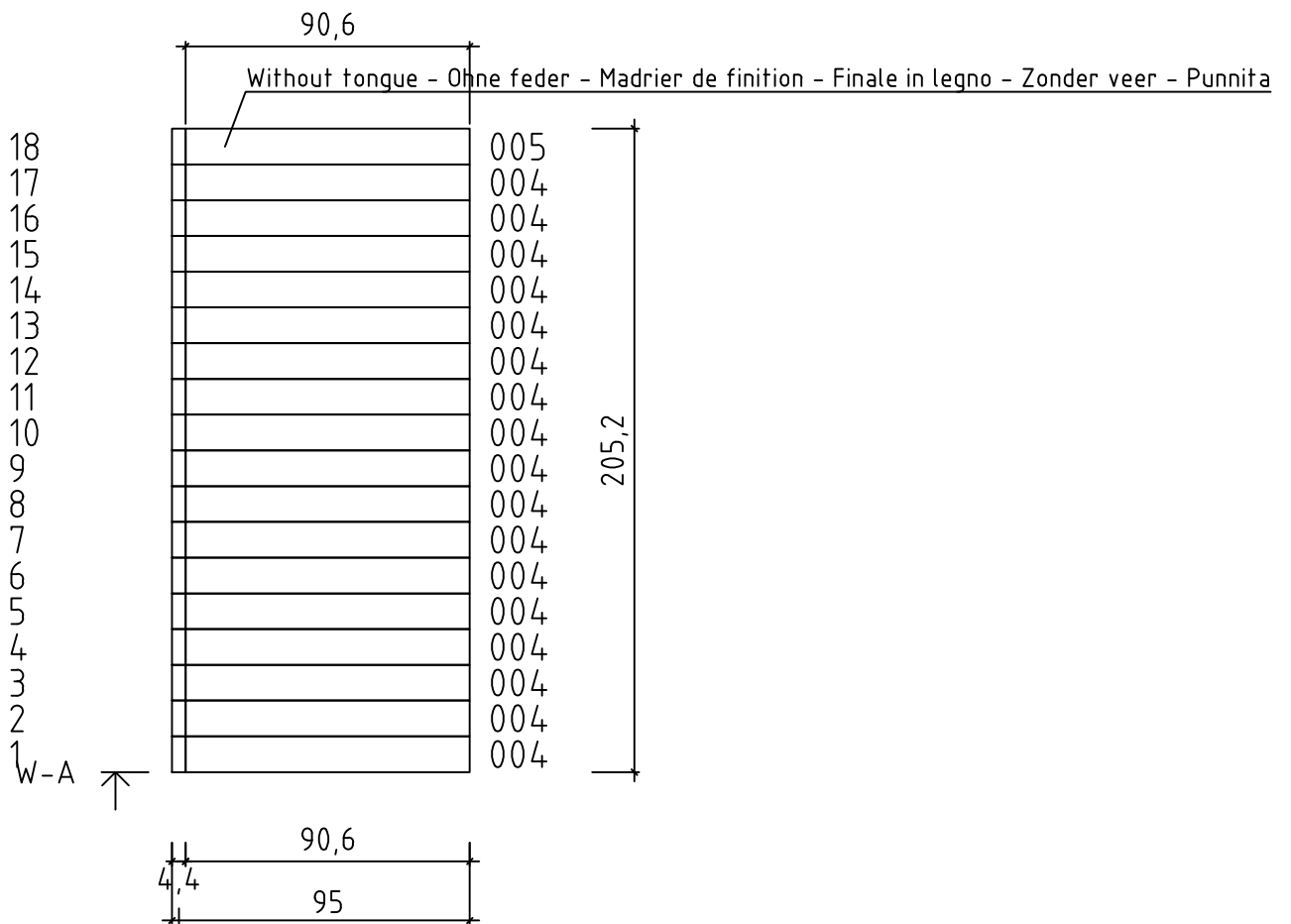
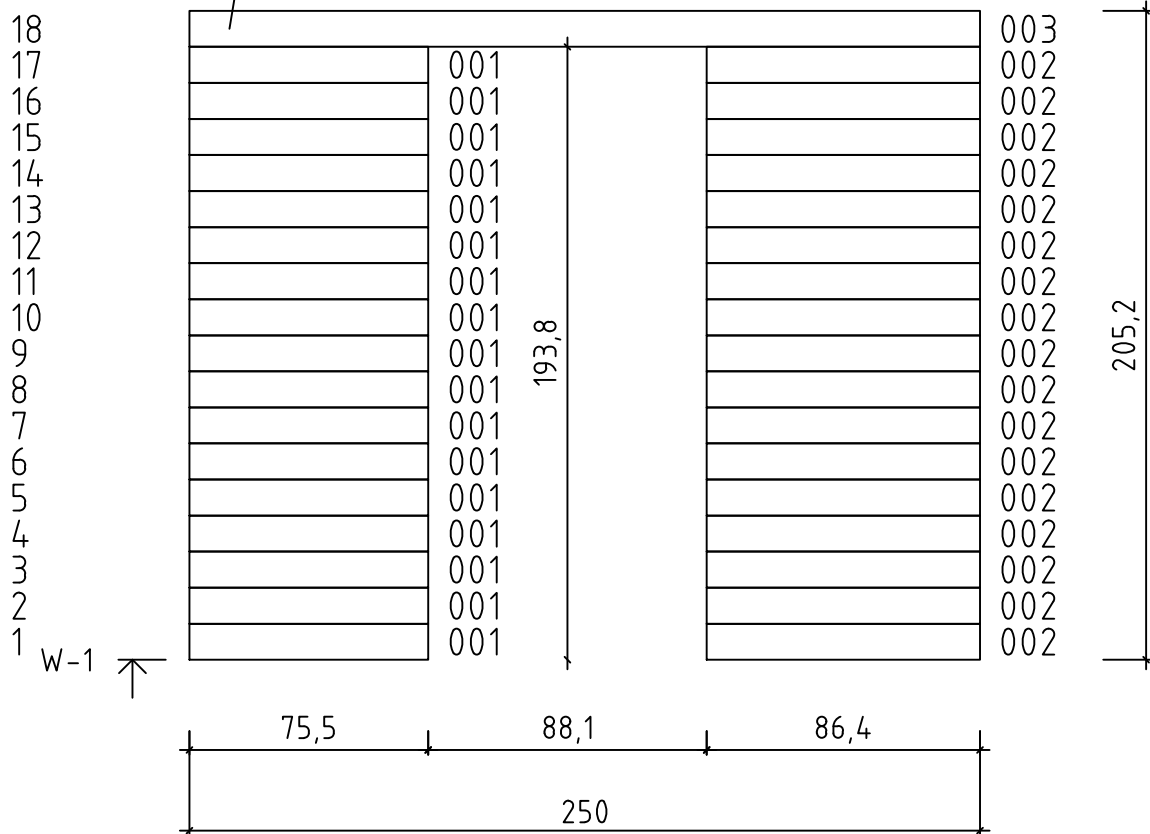



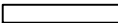

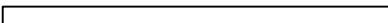

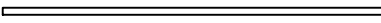
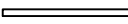
Art. Nr. 9901400

Without tongue - Ohne feder - Madrier de finition - Finale in legno - Zonder veer - Punnita

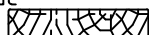
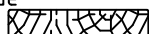
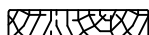
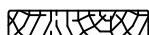

1

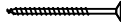
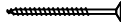
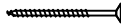
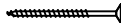
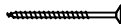
Pos	21.01.2020 Piece list - Stückliste - Liste des pièces - Elementi - Stuklijst - Tükítabel Art. Nr. 99014.00 4/17	Q	P (mm)	L (mm)
001		17	44x114	755
002		17	44x114	864
003		1	44x114	2500
004		17	44x114	906
005		1	44x114	906
RV2	Lath - Pfetten - Liteau - Piccola asse - Gordingen - Roov 	2	44x44	2456
RV1	Lath - Pfetten - Liteau - Piccola asse - Gordingen - Roov 	2	44x44	818
DB	Ceiling boards - Deckenbrett - Voliges sous plafond - Tavole per piano soffitto - Dakhout - Laelaud 	28	90x15	906
	Ceiling fillet - Deckeleiste - Profil de finition sous plafond - Massello per soffitto - Dak afdeklijst - Laeliist 		18x18	14
DL	Batten - Deckleiste - Profils de finition angles a l'exterieur - Asse - Afdek lijst - Katteliist 	2	15x40	2052
TS1	Rail holder for sliding door - Schiene für schiebetür, oben - Rail support pour porte coulissante - Supporto per porta scorrevole - Rails houder voor schuifdeur - Lükandukse kinniti 	1	28x34	1500
TS2	Rail holder cover for sliding door - Schiene für schiebetür, oben - Le couvrir de rail support pour porte coulissante - Supporto di copertura per porta scorrevole - Rails houder afdekkap voor schuifdeur - Lükandukse kinniti kate 	2	18x80	52
TS3	Rail holder cover for sliding door - Schiene für schiebetür, oben - Le couvrir de rail support pour porte coulissante - Supporto di copertura per porta scorrevole - Rails houder afdekkap voor schuifdeur - Lükandukse kinniti kate 	1	18x80	1500
CF1	Corner fillet - Deckleiste - Profils de finition angles a l'exterieur - Massello d'angolo - (hoek)lijst - Nurgaliist 	1	15x70	2052
CF2	Corner fillet - Deckleiste - Profils de finition angles a l'exterieur - Massello d'angolo - (hoek)lijst - Nurgaliist 	1	15x90	2052
CS	Corner stud - Eckpfosten - Poteaux d'angle pour fixation des madriers - Perno angolare - Hoek staander (kolom) - Nurgapost 	4	44x44	2000
FF	Fixing fillet - Fixirungsleiste - Profil de fixation - Massello di fissaggio - Bevestiging lijstwerk - Tenderlijst 	14	18x44	2714
HS7	Screw for sliding wall tie - Schieberegler für wand - Sabot métallique pour fixation mur - Vite per fissare scorrimento a c su slitta fissata alla parete - Schuifdeur instellingen wand - Kruvi seinaliugurile 	40	3.5x20	
HS4	Screw for corner fillet - Schraube zur befestigung deckleiste - Vis pour profils de finition angles a l'exterieur - Viti per massellino d'angolo - Schroef voor afdeklijst (hoek) - Kruvi nurgaliistule 	28	3x30	
HS14	Screw for post - Schrauben für pfosten - Vis de fixation des poteaux - Viti per inviare - Schroef voor stijlen - Kruvi postile 	10	4.5x80	
HS14	Screw for wall details - Schraube für wand details - Vis pour mur details - Viti per elementi della porta - Schroef voor wand details - Kruvi seinte montaažiks 	122	4.5x80	
HS14	Screw for roof lath - Schraube für dachlatte - Vis pour latte - Vite per listello del tetto - Schroef voor daklat - Kruvi roovile 	18	4.5x80	
HS12	Screw for ceiling boards - Schrauben für deckenbrett - Vis de fixation des Voliges sous plafond - Viti per tavole per piano soffitto - Schroef voor dakhout - Kruvi laelauale 	60	4x40	

Art. Nr. 9901400

01

01

01

90,6

245,6

HS14

CS

HS14

21.01.2020

Modern corner connection - moderne Eckverbindung - Raccord d'angolo moderne - Connessione ad angolo moderna - Moderne
Hoekverbinding - Kruvitav tappideta nurgäühendus

6/17

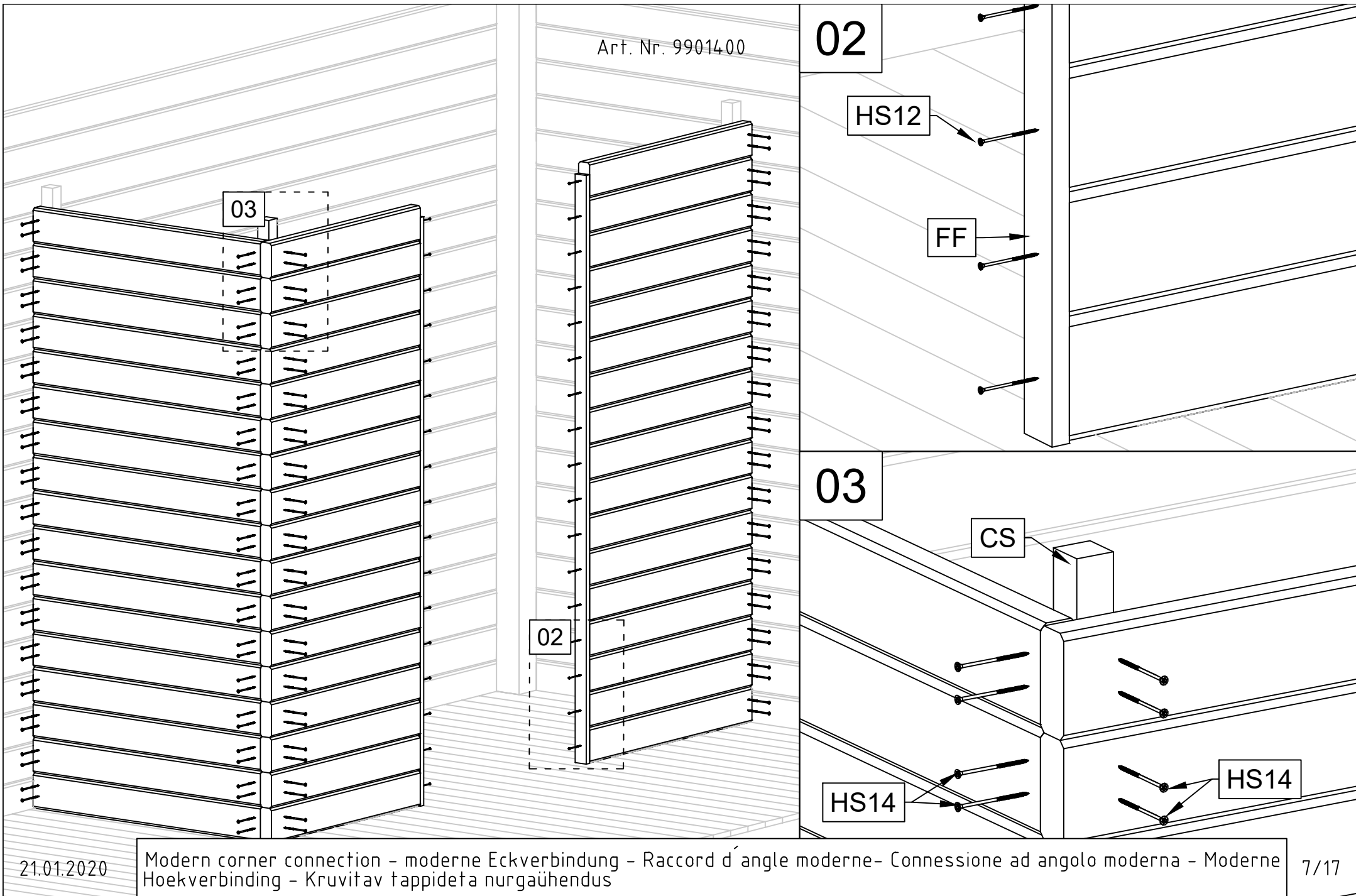

21.01.2020

Modern corner connection - moderne Eckverbindung - Raccord d'angle moderne - Connessione ad angolo moderna - Moderne
 Hoekverbinding - Kruvitav tappideta nurgäühendus

Art. Nr. 9901400

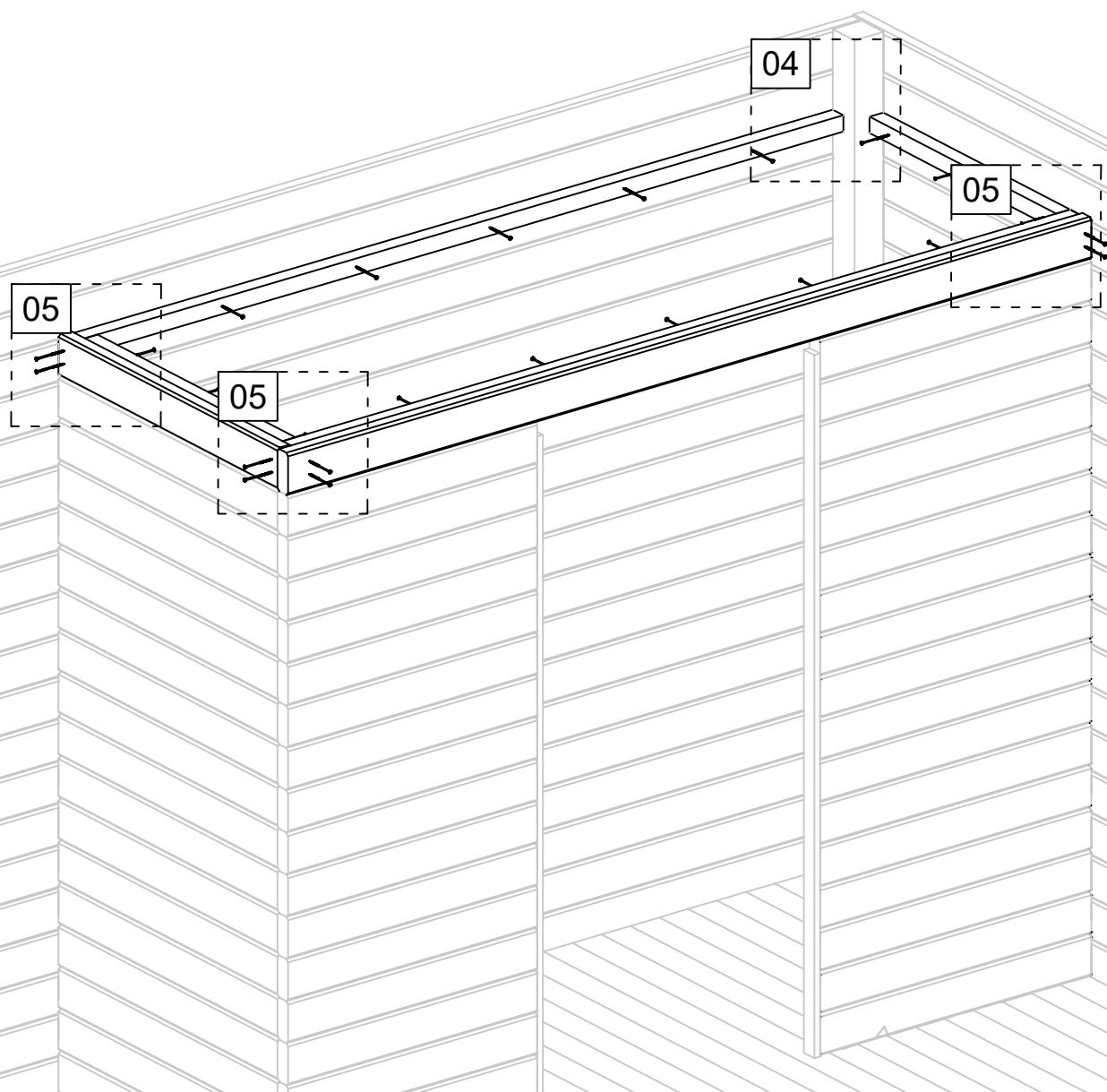

04

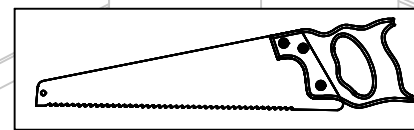

RV2

RV1

HS14

HS14

05

RV2

RV2

RV1

HS14

21.01.2020

Modern corner connection - moderne Eckverbindung - Raccord d'angle moderne - Connessione ad angolo moderna - Moderne Hoekverbinding - Kruvitav tappideta nurgäühendus

8/17

Art. Nr. 99014.00

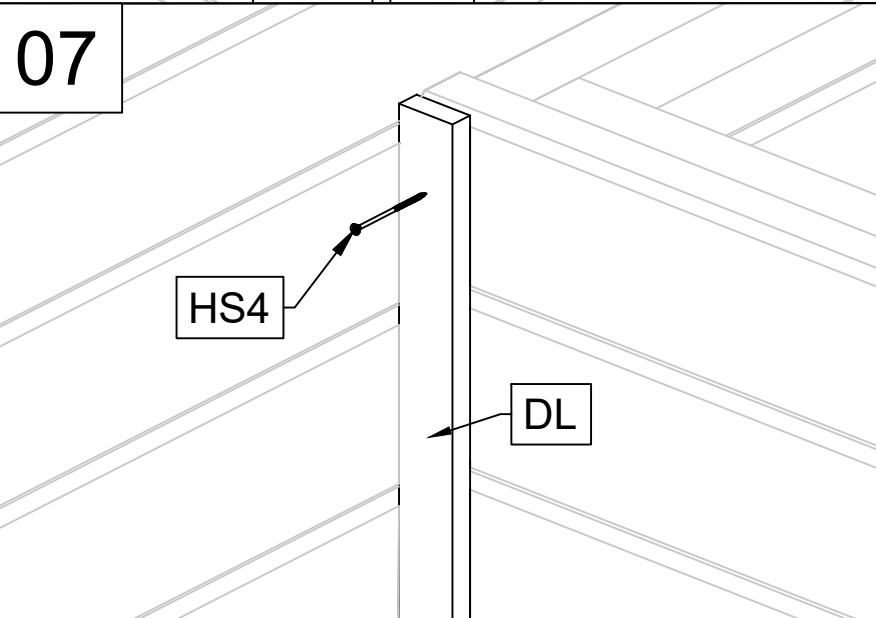
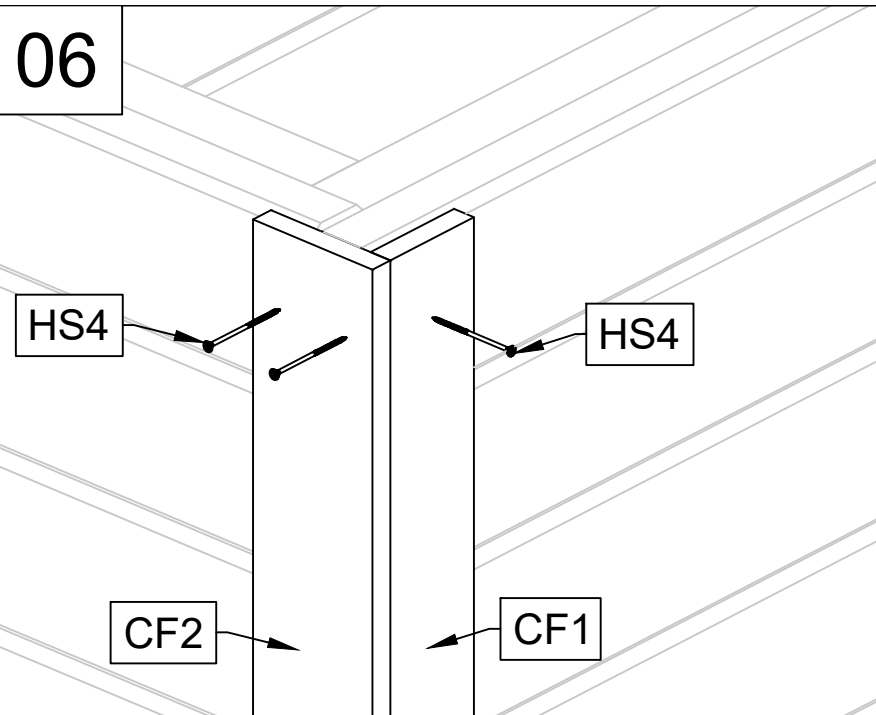
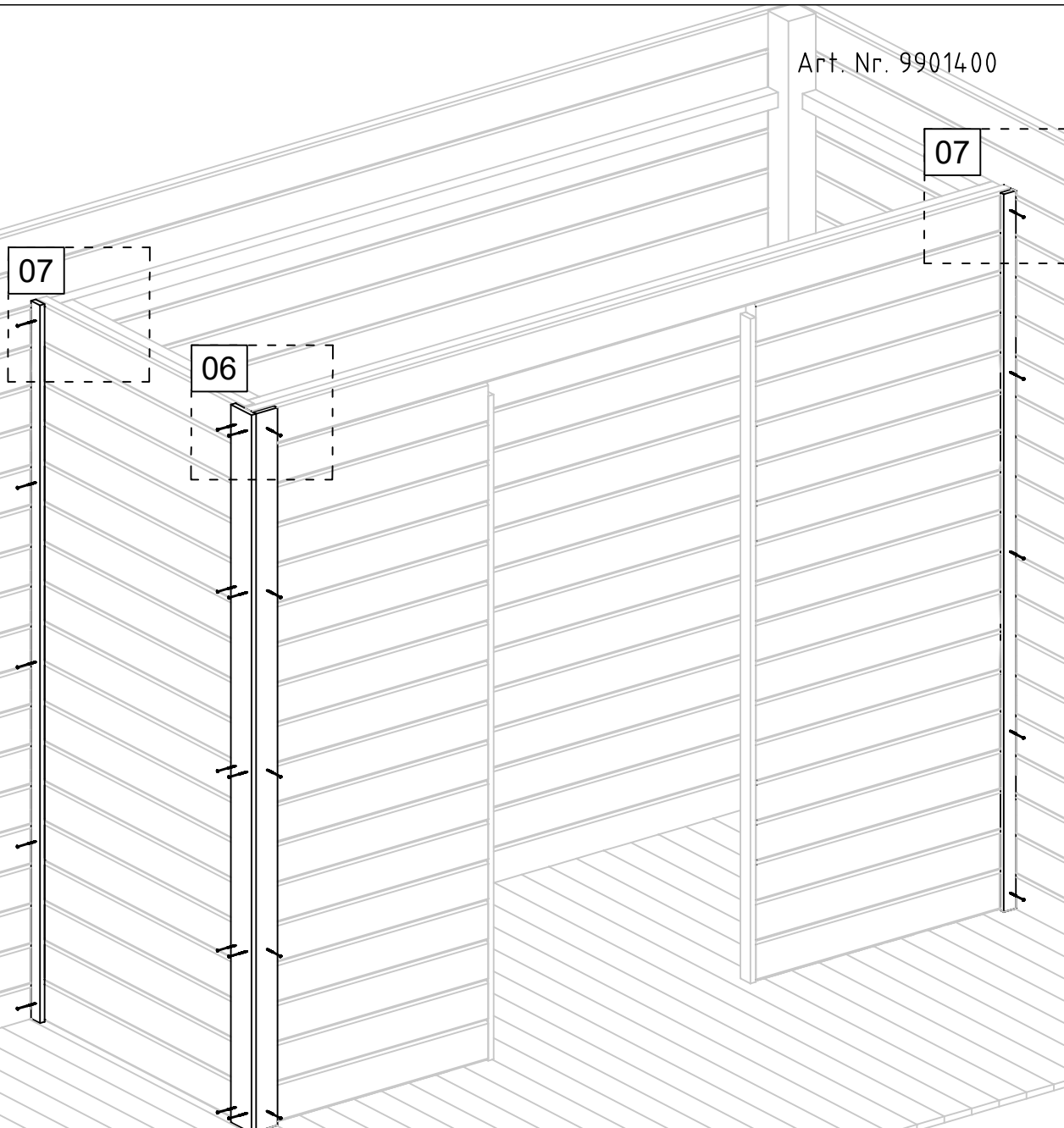

21.01.2020

Modern corner connection - moderne Eckverbindung - Raccord d'angle moderne - Connessione ad angolo moderna - Moderne
Hoekverbinding - Kruvitav tappideta nurgäühendus

Art. Nr. 9901400

08/09

08/09

08

DB

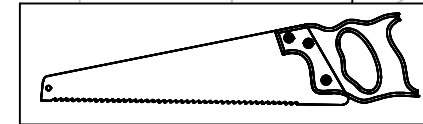

09

DB

HS12

21.01.2020

Modern corner connection - moderne Eckverbindung - Raccord d'angle moderne - Connessione ad angolo moderna - Moderne Hoekverbinding - Kruvitav tappideta nurgäühendus

10/17

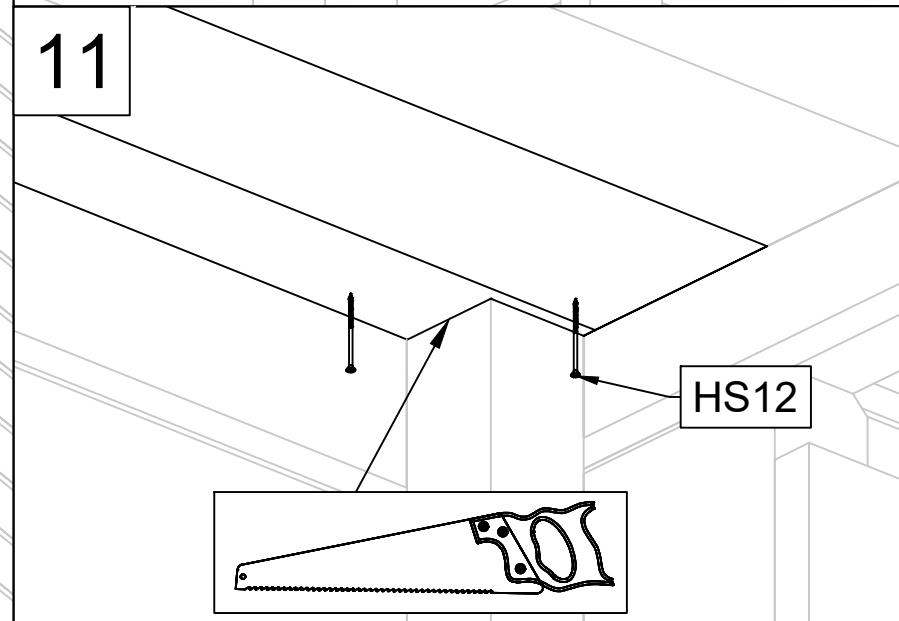
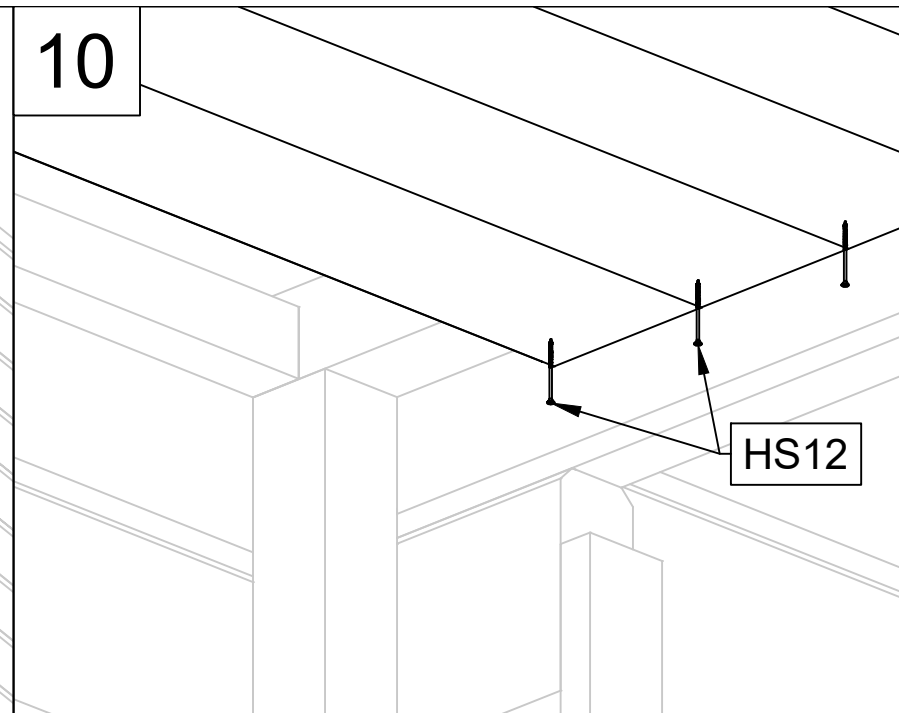
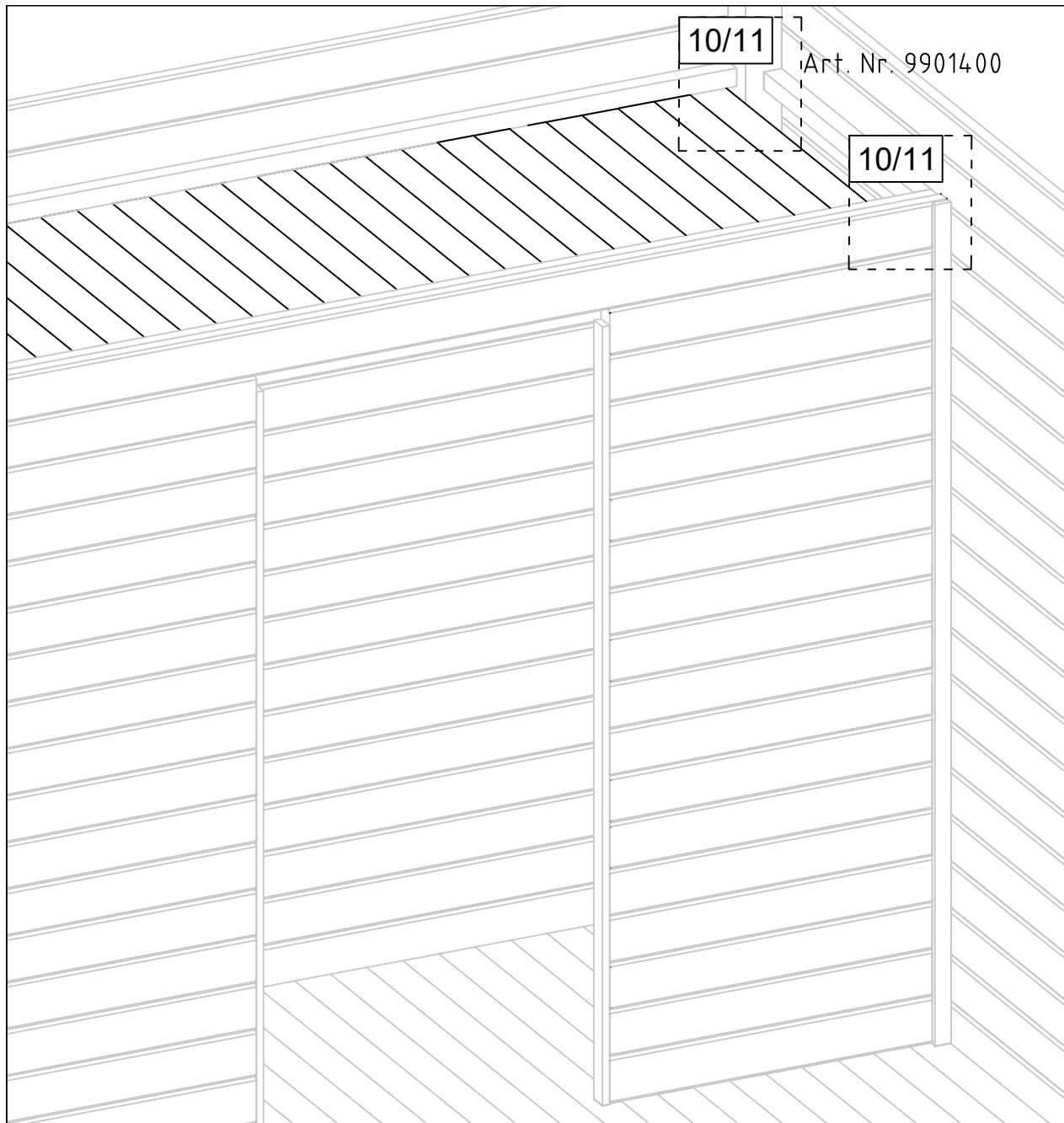

21.01.2020

Modern corner connection - moderne Eckverbindung - Raccord d'angolo moderne - Connessione ad angolo moderna - Moderne Hoekverbinding - Kruvitav tappideta nurgähendus

11/17

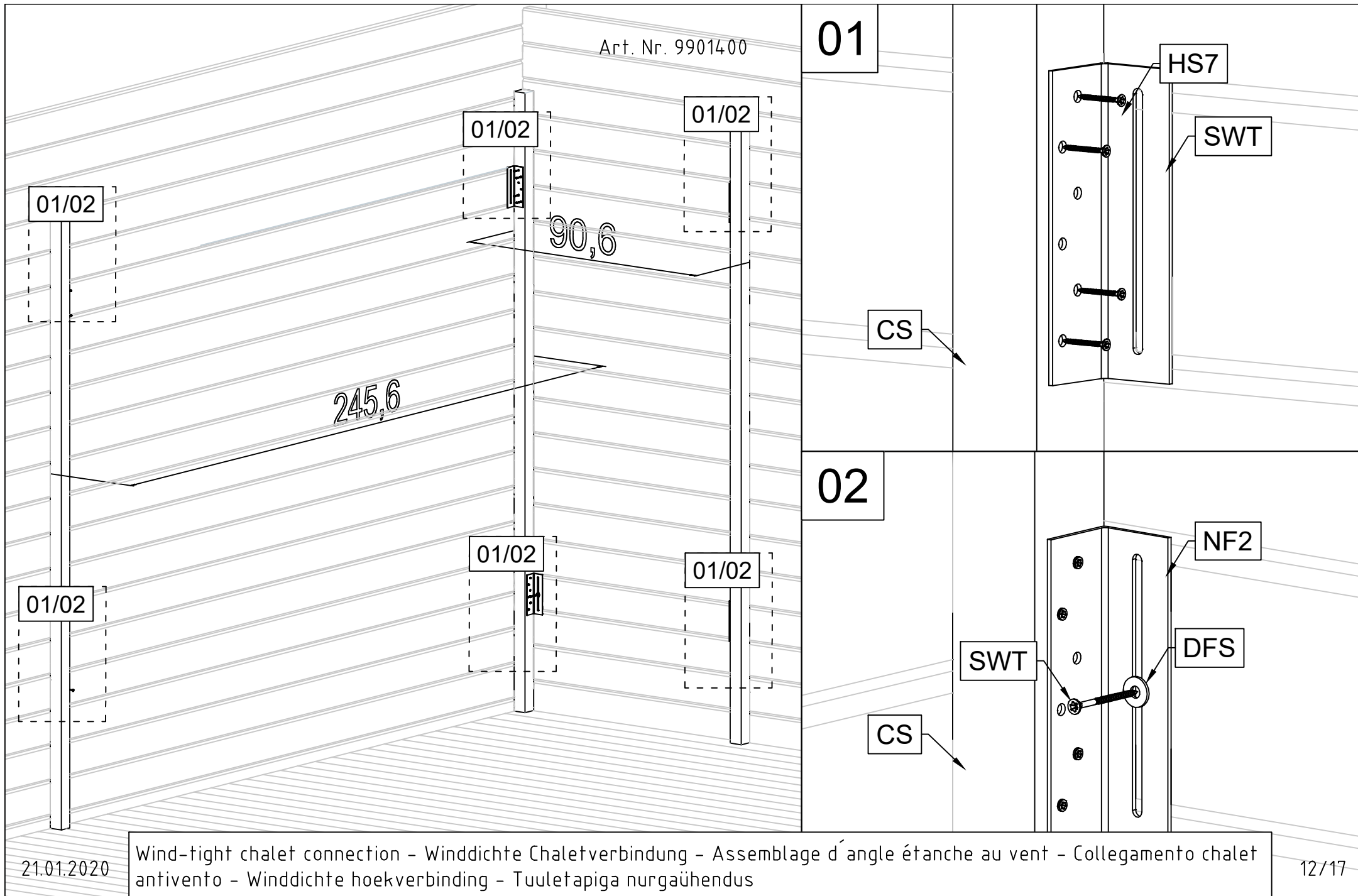

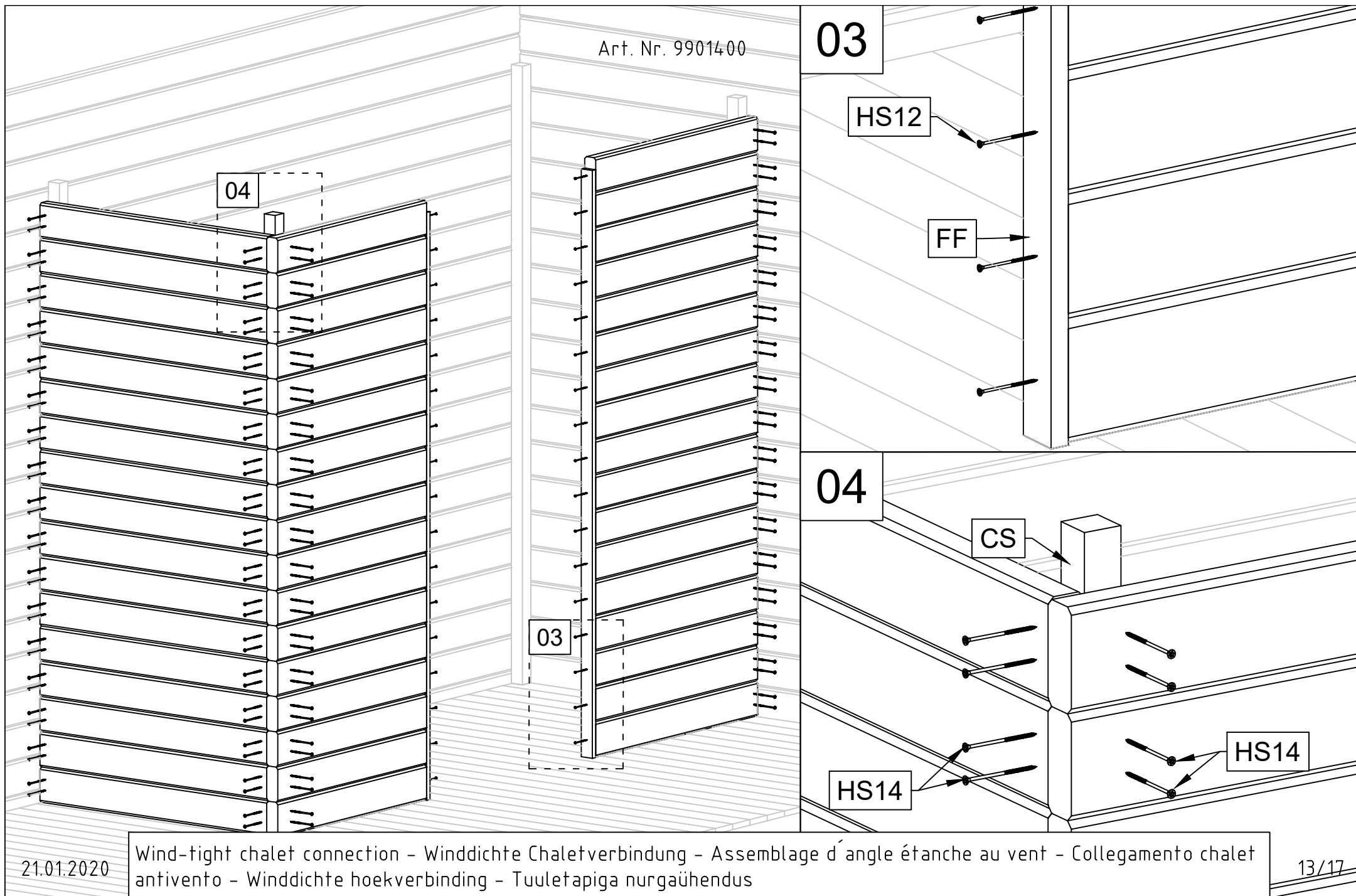

Art. Nr. 99014.00

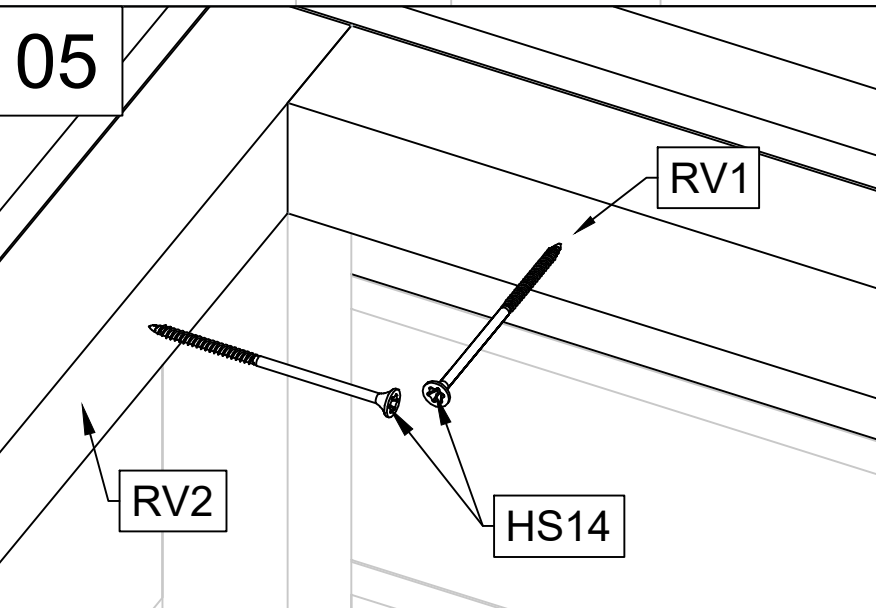
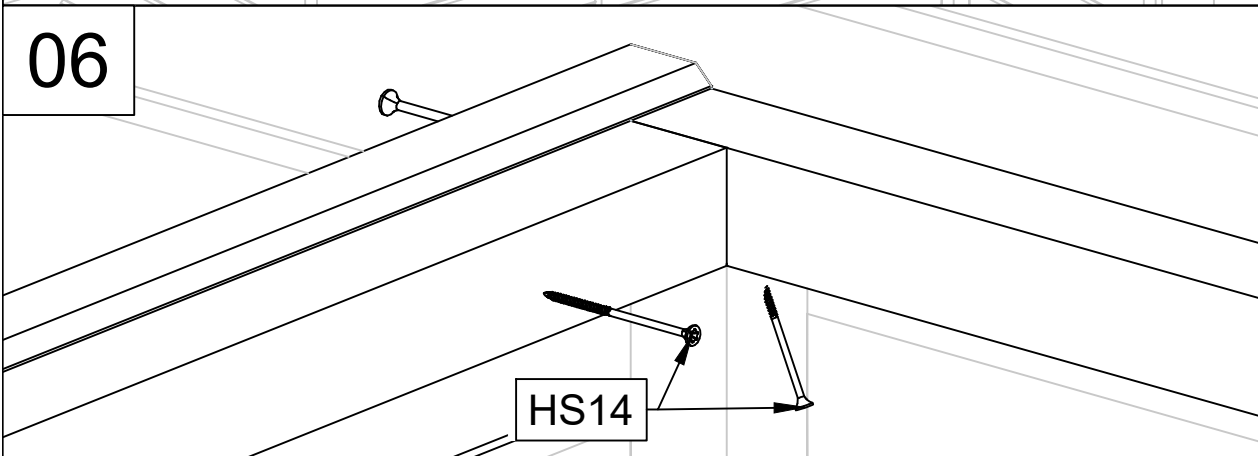
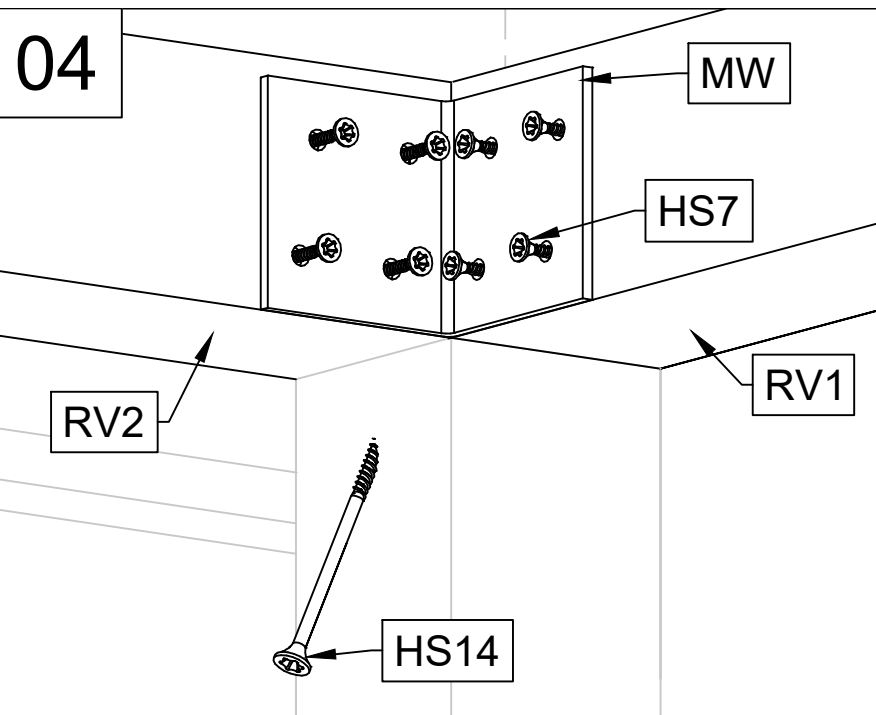
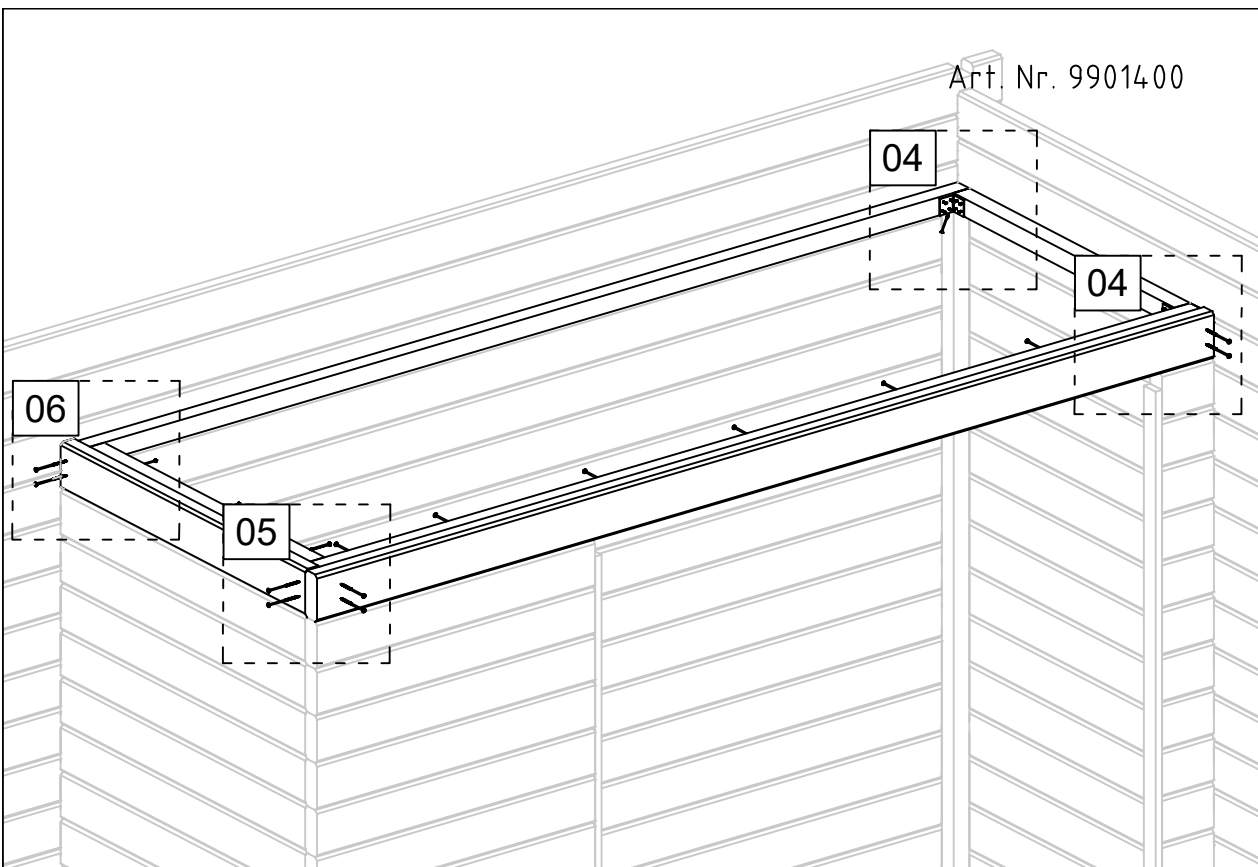

21.01.2020

Wind-tight chalet connection - Winddichte Chaletverbindung - Assemblage d'angle étanche au vent - Collegamento chalet antivento - Winddichte hoekverbinding - Tuuletapiga nurgäühendus

Art. Nr. 9901400

08

07

08

07

HS4

HS4

CF2

CF1

08

HS4

DL

21.01.2020

Wind-tight chalet connection - Winddichte Chaletverbindung - Assemblage d'angle étanche au vent - Collegamento chalet antivento - Winddichte hoekverbinding - Tuuletapiga nurgäühendus

15/17

Art. Nr. 9901400

09/10

09/10

09

DB

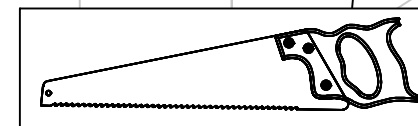

10

DB

HS12

21.01.2020

Wind-tight chalet connection - Winddichte Chaletverbindung - Assemblage d'angle étanche au vent - Collegamento chalet antivento - Winddichte hoekverbinding - Tuuletapiga nurgäühendus



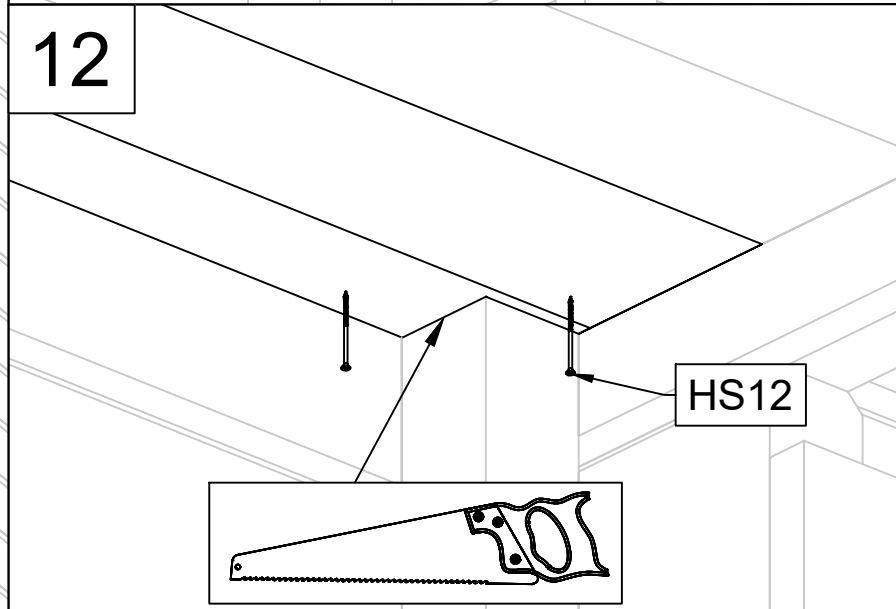
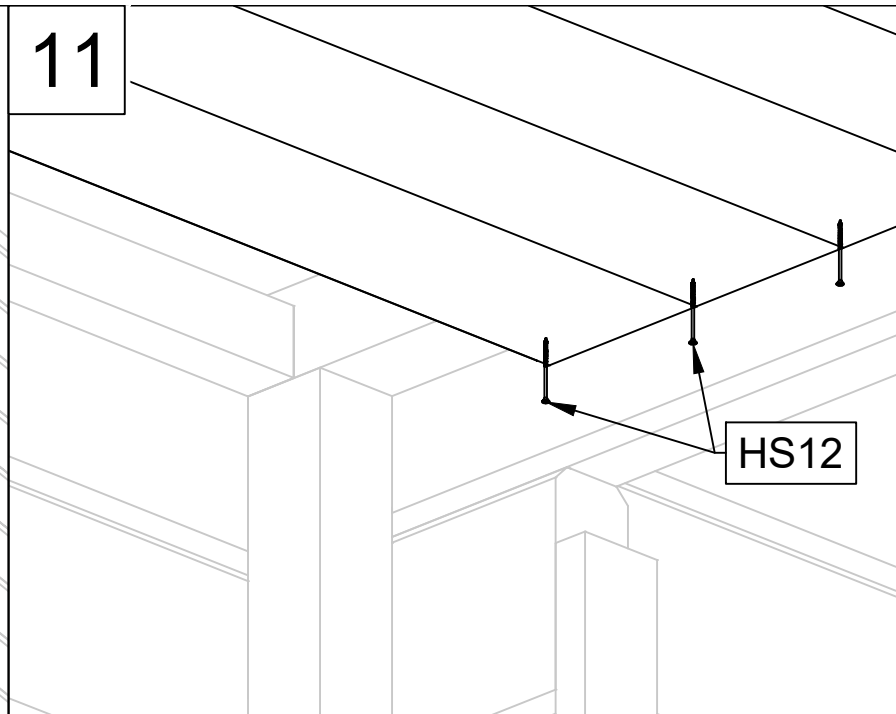
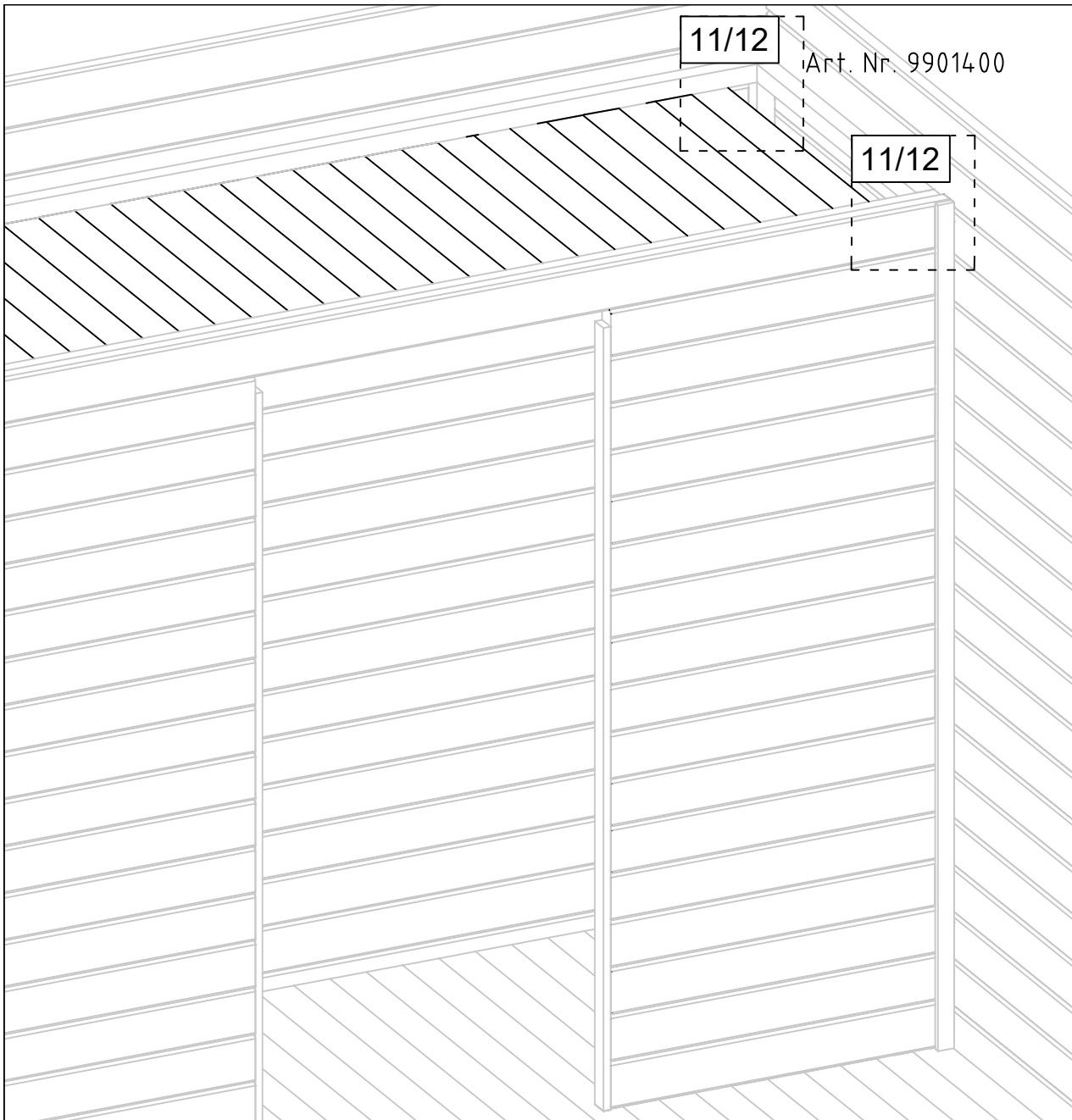



16/17

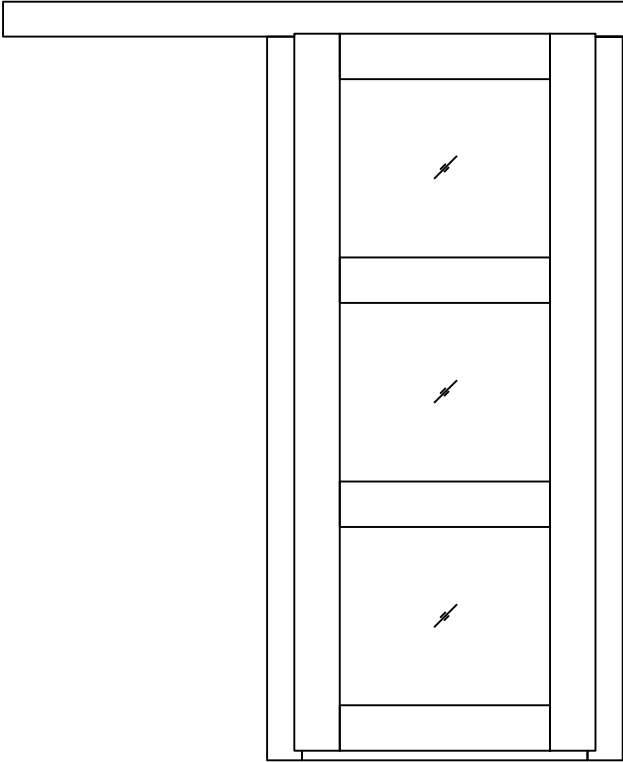
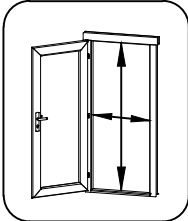
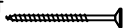
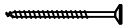
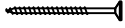
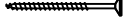

21.01.2020

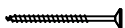
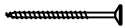
Wind-tight chalet connection - Winddichte Chaletverbindung - Assemblage d'angle étanche au vent - Collegamento chalet antivento - Winddichte hoekverbinding - Tuuletapiga nurgäühendus

17/17

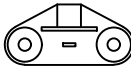
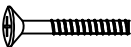
Pos	14.01.2020	Piece list - Stückliste - Liste des pièces - Elementi - Stuklijst - Tükitalabel 835x1900 UK.3.030.MLV.Mb MGP	1/1	Q	P (mm)	L (mm)
		  <p>735x1868 mm</p>				
HS1	Screw for rail - Schraube für schiene - Vis pour rail - Vite per binario - Schroef voor rails - Kruvi siinile		6	4x30		
HS8	Screw for fixing sliding door - Schraube zur Befestigung der schiebetür - Vis de fixation porte coulissante - Vite per fissaggio porta scorrevole - Schroef voor bevestiging schuifdeur - Kruvi lükandukse montaažiks		9	3.5x35		
HS13	Screw for fixing sliding door - Schraube zur Befestigung der schiebetür - Vis de fixation porte coulissante - Vite per fissaggio porta scorrevole - Schroef voor bevestiging schuifdeur - Kruvi lükandukse montaažiks		8	4x60		
HS16	Screw for door jamb - Schraube für Türrahmen - Vis de fixation partie haute avec montants du cadre de porte - Viti x fissaggio montanti porte - Schroef voor deurkozijn - Kruvi ukse lengile		4	5x90		
HS16	Screw for fixing door to the wall - Schraube zur Befestigung für - zarge mit wand - Vis de fixation partie basse dormants de porte au 1er rang de madrier - Viti per fissare la porta alla parete - Schroef voor bevestiging deur naar wand - Kruvi ukse lengi kinnifamiseks seinale		2	5x90		
TS4	Rail - Schiene - Rail - Guida binaria - Rails - Lükandukse juhtsiin		1	28x31	1620	
HS5	Screw for sliding door support plate - Schraube für Zubehör für Türblatt - Vis pour la plaque du support de la porte coulissante - Vite per piastra di supporto porta scorrevole - Schroef voor schuifdeur deurbeslag - Kruvi lükandukse kandeplaadile		8	3.5x40		
HS7	Screw for fixing sliding door - Schraube zur Befestigung der schiebetür - Vis de fixation porte coulissante - Vite per fissaggio porta scorrevole - Schroef voor bevestiging schuifdeur - Kruvi lükandukse montaažiks		4	3.5x25		
TS5	Rail for door - Schiene für Türblatt, unten - Patin de guidage - Guida per porta - Deur rails - Lükandukse alumine juhik		1	4.5x65		
TS6	Sliding door support plate - Zubehör für Türblatt - La plaque du support de porte coulissante - Piastra di supporto per porta scorrevole - Deur toebehoren - Lükandukse kandeplaat		2	3x30		
TS8	Fixator for sliding door - Fixer für schiebetür - Boutee d'arrêt porte coulissante - Fissatore per porta scorrevole - Bevestiging voor schuifdeur - Lükandukse lahtihoiufiksaator		2	3.5x15		
TS11	Roller for sliding door - Laufrad für schiebetür - Ferrure pour porte coulissante - Rullo per porta scorrevole - Wielkatrol voor schuifdeur - Lükandukse vanker		2	3.5x35		
TS12	Bolt for sliding door roller - Bolzen für schiebetür laufrad - Boulon pour roller de porte coulissante - Bullone per rullo porta scorrevole - Schuifdeur bout - Lükandukse vankri ja kandeplaadi ühenduspolt		2	3.5x35		

