

Art. Nr. 2853500
1/21



19.10.2023

Art. Nr. 2853500

Groundplan - Grundplan - Plan de masse -
Planimetria - Plattegrond - Põhiplaan

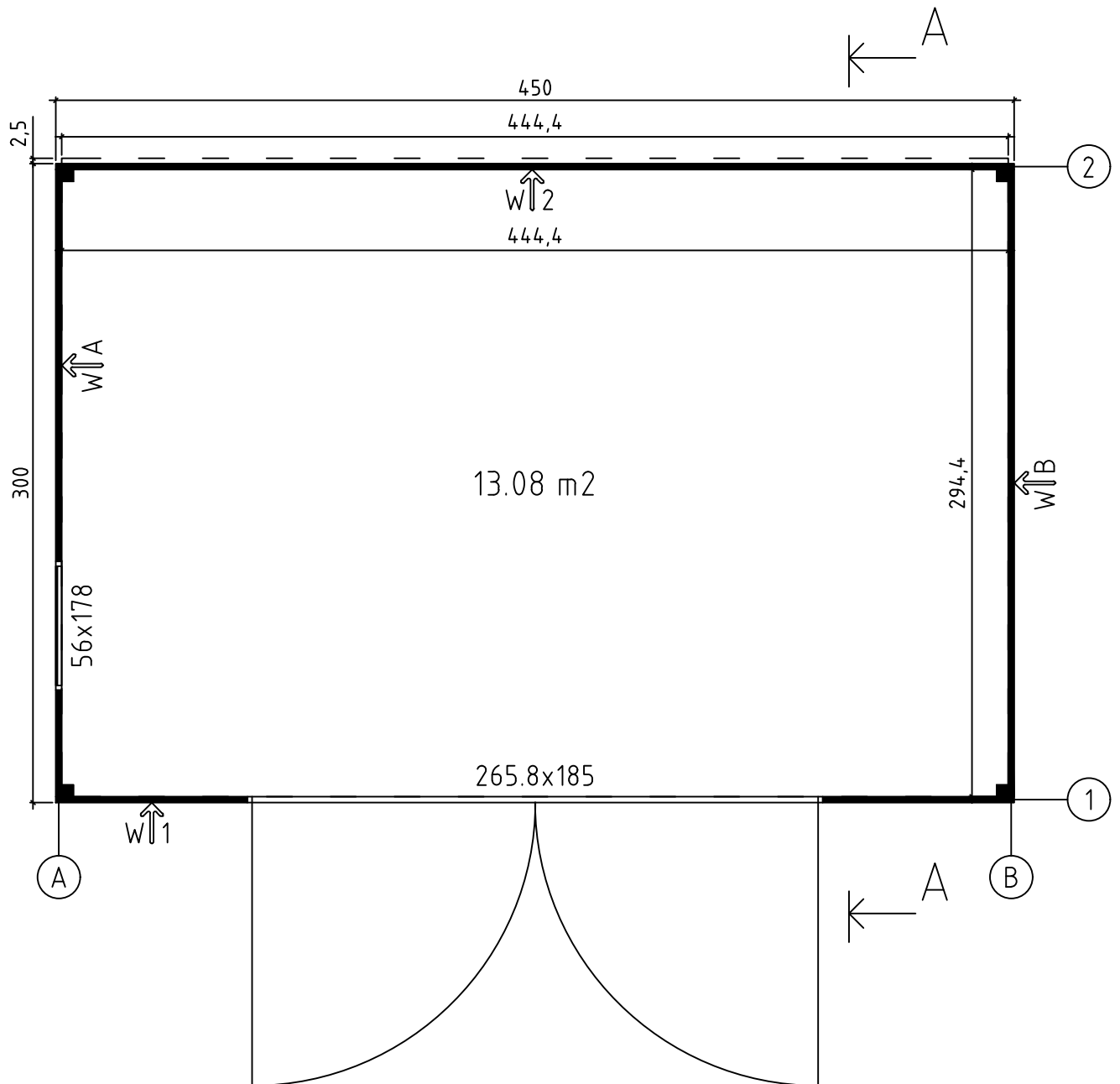

Art. Nr. 2853500

Foundation - Fundament - Fondation -
Fondamenta - Fundering - Immutatud alusraam

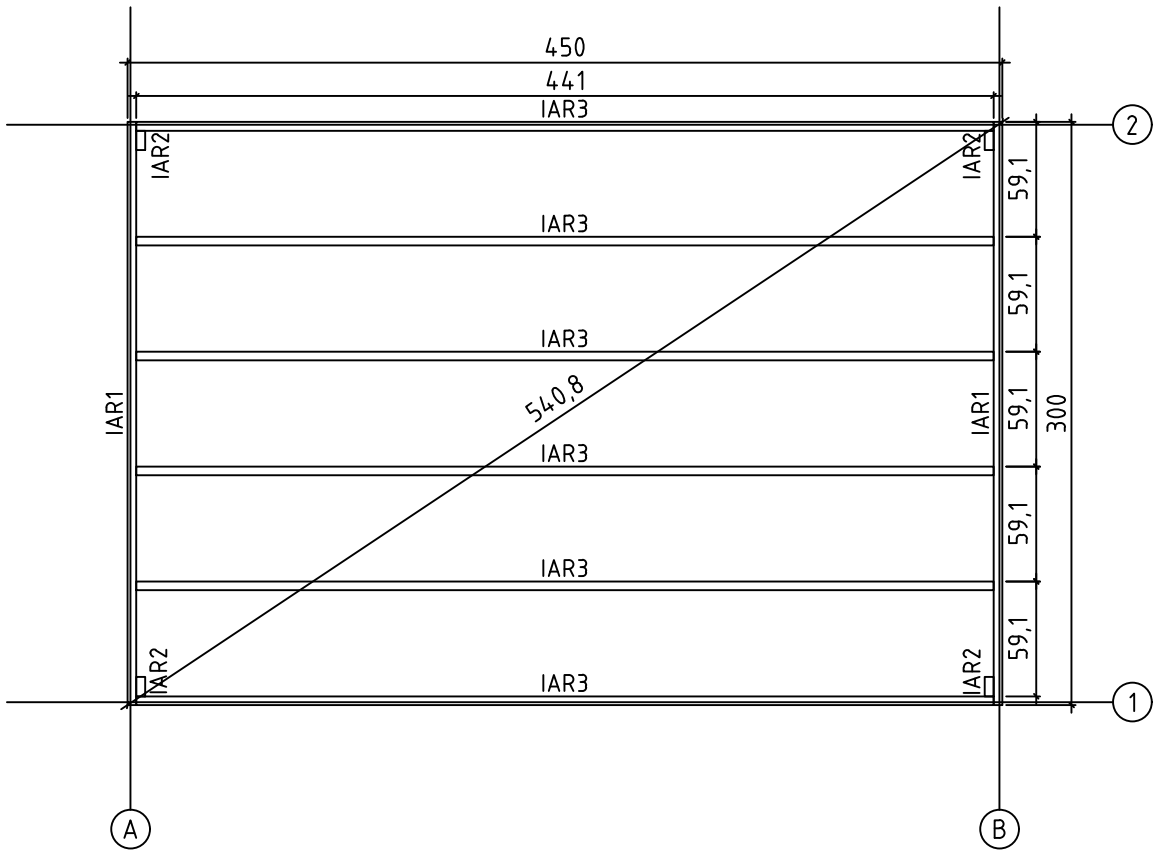

Floor boards - Fussbodenbretter - Plan pose plancher -
Pavimento - Vloerhout - Põrandalaudis

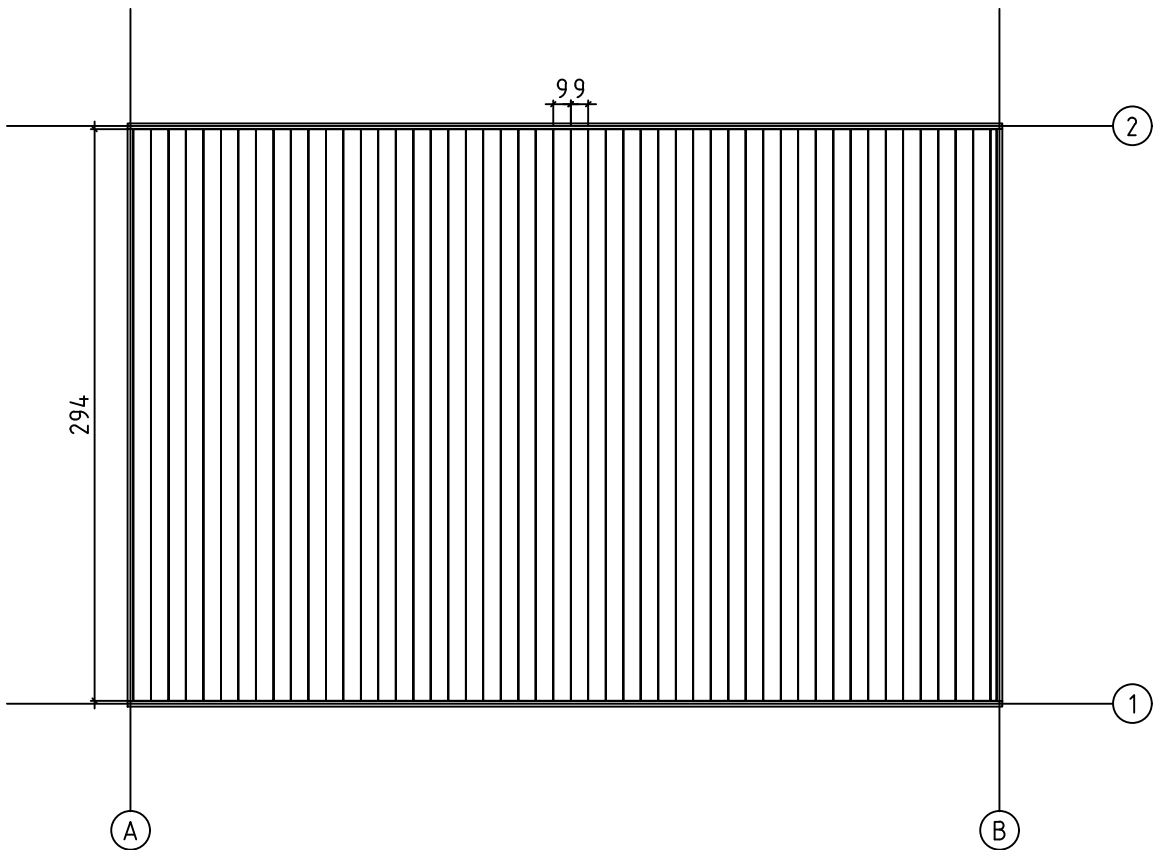

Art. Nr. 2853500



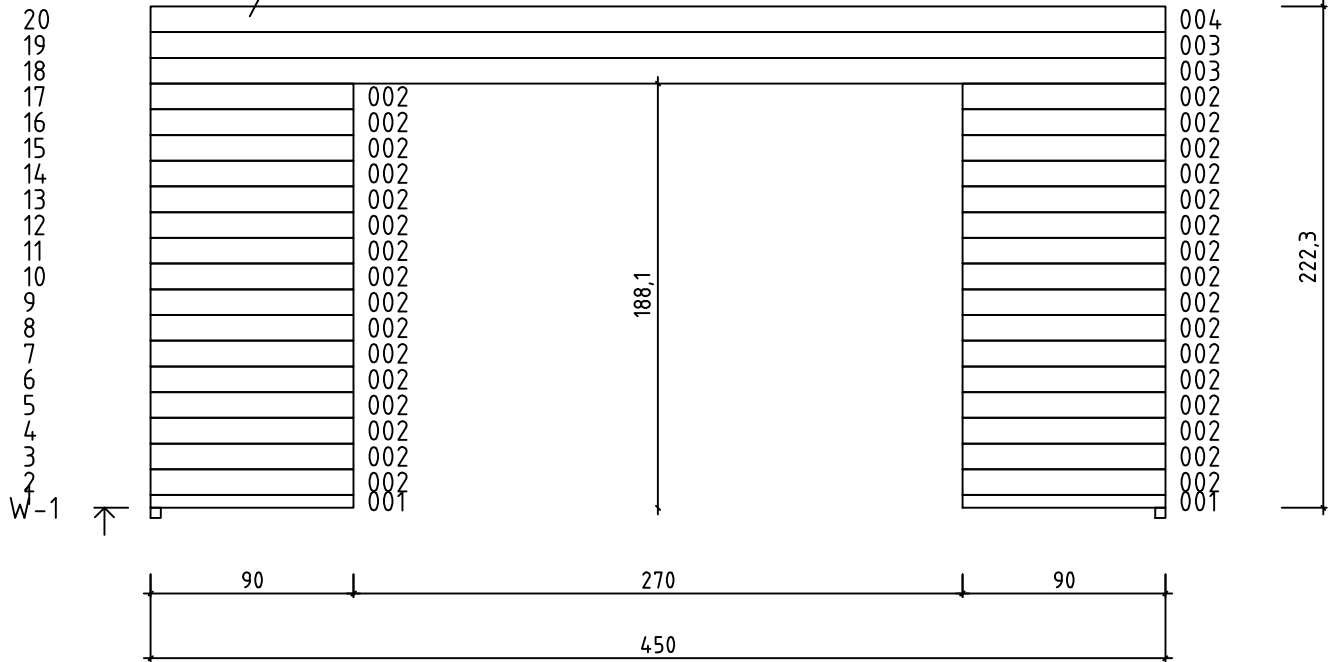



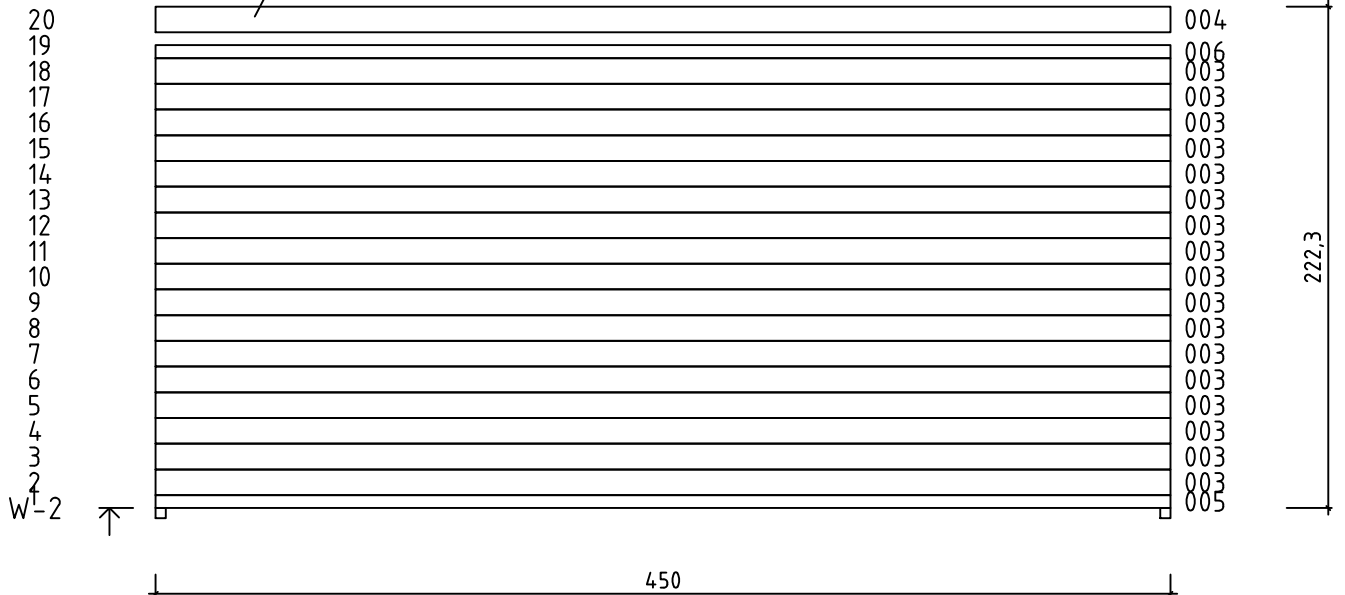

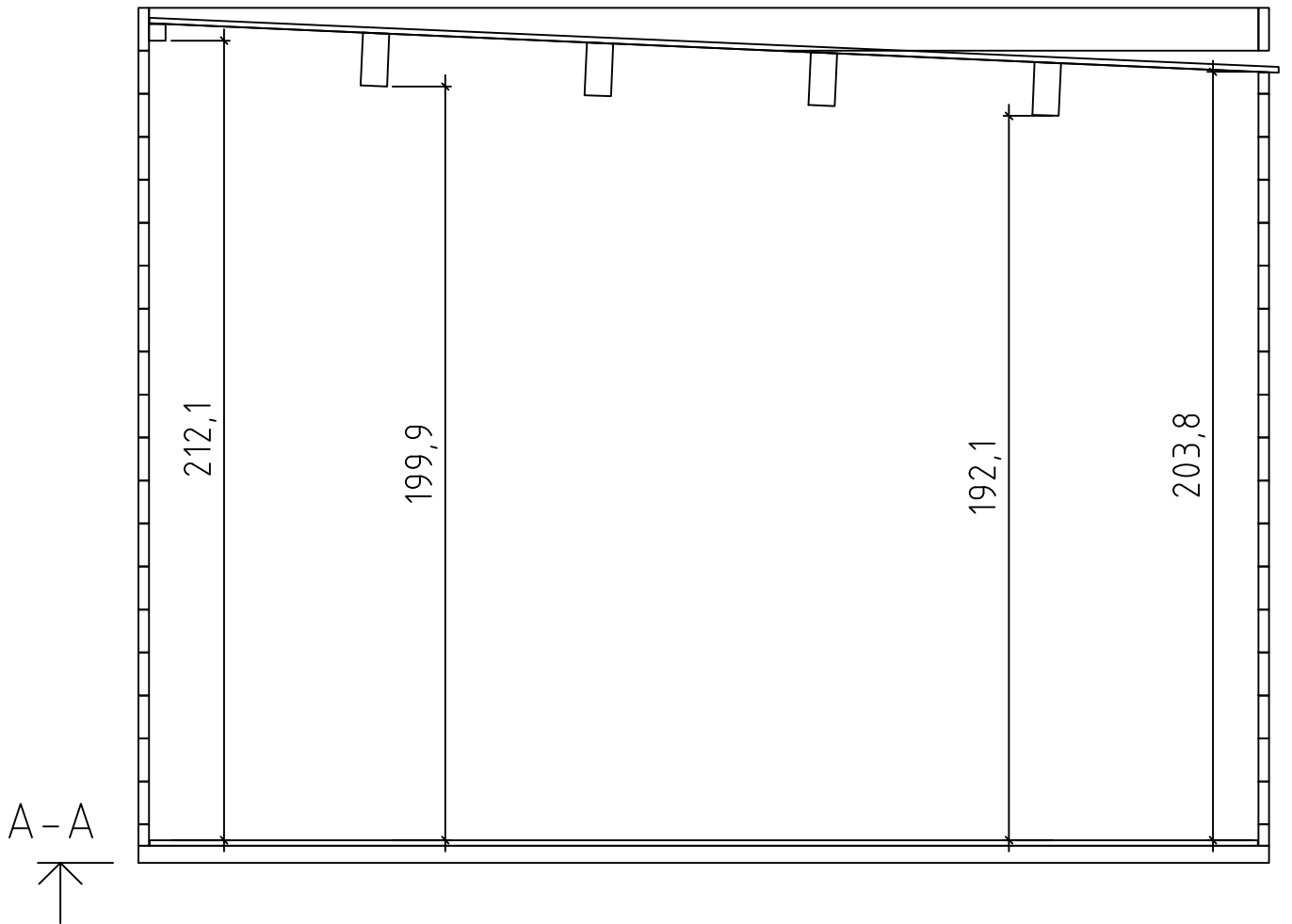

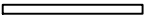

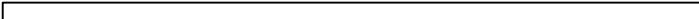

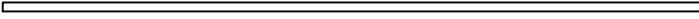
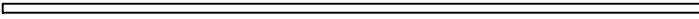

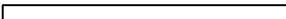
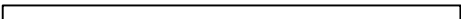
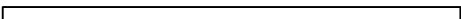

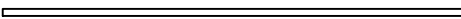
Without tongue - Ohne feder - Madrier de finition -
Finale in legno - Zonder veer - Punnita

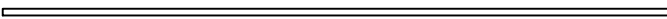







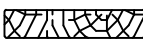

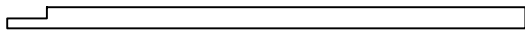



Without tongue - Ohne feder - Madrier de finition -
Finale in legno - Zonder veer - Punnita

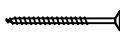
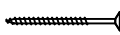
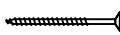
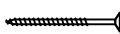
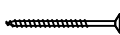

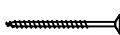

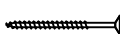
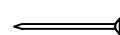
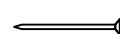
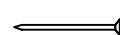
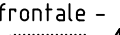
| Pos | 19.10.2023 Piece list - Stückliste - Liste des pièces - Elementi - Stuklijst - Tükitalabel Art. Nr. 2853500 7/21 | Q | P (mm) | L (mm) |
|----------------|---|----|-----------|-----------|
| 001 44715 |  | 2 | 28x57 | 900 |
| 002 44716 |  | 32 | 28x114 | 900 |
| 003 44717 |  | 19 | 28x114 | 4500 |
| 004 44718 |  | 2 | 28x114 | 4500 |
| 005 44722 |  | 1 | 28x57 | 4500 |
| 006 44719 |  | 1 | 28x57 | 4500 |
| 007 23530 |  | 2 | 28x57 | 2944 |
| 008 5690 |  | 16 | 28x114 | 500 |
| 009 41073 |  | 16 | 28x114 | 1840 |
| 010 18093 |  | 20 | 28x114 | 2944 |
| 011 44379 |  | 2 | 28x114 | 2944 |
| IAR3 26160 | Foundation - Fundament - Fondation - Fondamenta - Fundering - Immutatud alusraam  | 6 | 45x45 | 4410 |
| IAR1 21752 | Foundation - Fundament - Fondation - Fondamenta - Fundering - Immutatud alusraam  | 2 | 45x45 | 3000 |
| IAR2 44380 | Foundation - Fundament - Fondation - Fondamenta - Fundering - Immutatud alusraam  | 4 | 45x45 | 100 |
| RV1 44720 | Lath - Pfetten - Liteau - Piccola asse - Gordingen - Roov  | 1 | 44x44 | 4334 |
| A-PR1 44721 | Roof beam - Dachbalken - Panne de toit - Perlina del tetto - Gordingen / dakbalk - Pärilin  | 4 | 70x140 | 4436 |
| FB 23056 | Floor boards - Fussbodenbretter - Lame de plancher - Pavimento - Vloerhout - Põrandalaud  | 50 | 90x15 | 2940 |
| RB 33576 | Roof boards - Dachbretter - Voliges - Perlina per tetto - Dakhout - Katuselaud  | 50 | 90x15 | 3000 |
| FL-1 30087 | Floor fillet - Fussbodenteiste - Corniere de finition du plancher - Finitura per pavimento (battisco pa) - Vloerafwerklijst - Põrandaliist  | | 18x18 | 16 |
| P1 44712 | Post - Pfosten - Poteau - Piede registrabile - Stijl - Post  | 2 | 55x55 | 2050 |
| P2 44713 | Post - Pfosten - Poteau - Piede registrabile - Stijl - Post  | 2 | 55x55 | 2180 |
| CF1 41635 | Corner fillet - Deckleiste - Profils de finition angles a l'exterieur - Massello d'angolo - (hoek)lijst - Nurgaliist  | 4 | 15x70 | 2223 |
| CF2 44711 | Corner fillet - Deckleiste - Profils de finition angles a l'exterieur - Massello d'angolo - (hoek)lijst - Nurgaliist  | 2 | 15x90 | 2223 |

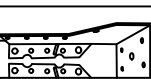
| Pos | 19.10.2023 Piece list - Stückliste - Liste des pièces - Elementi - Stuklijst - Tükítabel Art. Nr. 2853500 8/21 | Q | P (mm) | L (mm) |
|---------------|---|-----|-----------|-----------|
| CF3 46940 | Corner fillet - Deckleiste - Profils de finition angles a l'exterieur - Massello d'angolo - (hoek)lijst - Nurgaliist  | 2 | 15x90 | 2223 |
| TB 47097 | Fascia board - Traufbrett - Bandeau de toit - Finitura lati tetto - Gevellijst - Räästalaud  | 1 | 15x45 | 4444 |
| 44292 | Fascia sheet - Abschlussprofil - Profil de finition métallique pour débord de toiture - Scossalina di protezione dall'acqua per bordo di legno - Afdek profiel / boordprofiel - Räästaplekk  | 4 | | 2200 |
| 44727 | Fascia sheet - Abschlussprofil - Profil de finition métallique pour débord de toiture - Scossalina di protezione dall'acqua per bordo di legno - Afdek profiel / boordprofiel - Räästaplekk  | 2 | | 2900 |
| FF1 43853 | Fixing fillet - Fixierungsleiste - Profil de fixation - Massello di fissaggio - Bevestiging lijstwerk - Tenderliist  | 2 | 18x28 | 1800 |
| FF2 23522 | Fixing fillet - Fixierungsleiste - Profil de fixation - Massello di fissaggio - Bevestiging lijstwerk - Tenderliist  | 2 | 18x28 | 1850 |
| HS4 5102 | Screw for corner fillet - Schraube zur befestigung deckleiste - Vis pour profils de finition angles a l'exterieur - Viti per massellino d'angolo - Schroef voor afdekljst (hoek) - Kruvi nurgaliistule  | 40 | 3x30 | |
| HS4 5102 | Screw for fascia boards - Schrauben für traufbretter - Vis pour fixation bandeau de toit - Viti x striscia del tetto - Schroef voor gevellijst - Kruvi räästalauale  | 8 | 3x30 | |
| HS12 5109 | Screw for beam holder - Schrauben für balkenhalter - Vis de fixation support "u" galvanisé - Vite per trave di sostegno - Schroef voor bevestiging balkhouder (gordingschoen) - Kruvi talakingale  | 48 | 4x40 | |
| HS12 5109 | Screw for fixing fillet of door and window - Schrauben für fixierungsleiste - Vis pour profil vertical de fixation pour ouvertures des fenetres et portes - Viti per massello di fissaggio - Schroeven voor bevestiging van deur en raam lijsten - Kruvi tenderliistudele  | 66 | 4x40 | |
| HS13 5110 | Screw for wall details - Schraube für wand details - Vis pour mur details - Viti per elementi della porta - Schroef voor wand details - Kruvi seinadetailile  | 320 | 4x60 | |
| HS27 32038 | Screw for roof lath - Schraube für dachlatte - Vis pour latte - Vite per listello del tetto - Schroef voor daklat - Kruvi roovile  | 8 | 5x70 | |
| HS16 5115 | Screw for 1. wall beam - Schraube für 1. bohlenreihe - Vis de fixations 1ere rangée de madriers avec poutrelles de fondations - Vite fissaggio alle fondamenta - Schroef voor 1 wandbalk - Kruvi poollauale  | 17 | 5x90 | |
| HS16 5115 | Screw for foundation - Schrauben zur befestigung fundament - Vis de fixations des poutrelles de fondations - Viti x fondamenta - Schroef voor fundering - Kruvi alusraamile  | 16 | 5x90 | |
| HS23 5121 | Screw for wall details - Schraube für wand details - Vis pour mur details - Viti per elementi della porta - Schroef voor wand details - Kruvi seinadetailidele  | 21 | 6x180 | |
| HS29 | Screw for beam holder - Schrauben für balkenhalter - Vis de fixation support "u" galvanisé - Vite per trave di sostegno - Schroef voor bevestiging balkhouder (gordingschoen) - Kruvi talakingale  | 96 | 5x25 | |
| NF2 5127 | Zn nail for floor fillet - Zn nagel für fussbodenleiste - Pointe pour corniere de finition du plancher - Chiodi x fissaggio pavimento - Spijker(nagel) voor vloer afdekljst - Nael põrandaliistule  | 32 | 1.4x40 | |
| NF4 5137 | Zn nail for roof - Zn nagel für dachbretter - Pointe pour fixation voliges de toit - Chiodi x perline tetto - Spijker(nagel) voor dakhout - Nael katuselauale  | 310 | 2x50 | |
| NF4 5137 | Zn nail for floor - Zn nagel für fussbodenbretter - Clous pour plancher - Chiodi x perline pavimento - Spijker(nagel) voor vloer - Nael põrandalauale  | 310 | 2x50 | |
| 5602 | Screw for fascia sheet - Schraube für blende vis pour fascia - vite per lamiera frontale - Schroef voor boeiplaat - Kruvi räästaplekkile  | 80 | 4.8x32 | |
| FSC 44397 | Fascia sheet corner - Eckprofil - Profil d'habillage de rives - Scossalina di protezione dall'acqua per angolo di borbo in legno - Hoekprofiel - Räästapleki nurk  | 4 | | |
| BM 31254 | Beam holder - Balkenhalter - Support en u galvanisé - Supporto della trave Balkendrager (gording schoen) - Talaking  | 8 | 70x125 | |
| 43186 | Window - Fenster - Fenetre - Finestra - Raam - Aken 560x1780 AK.1.100.SSV SGC | 1 | | |

Art. Nr. 2853500

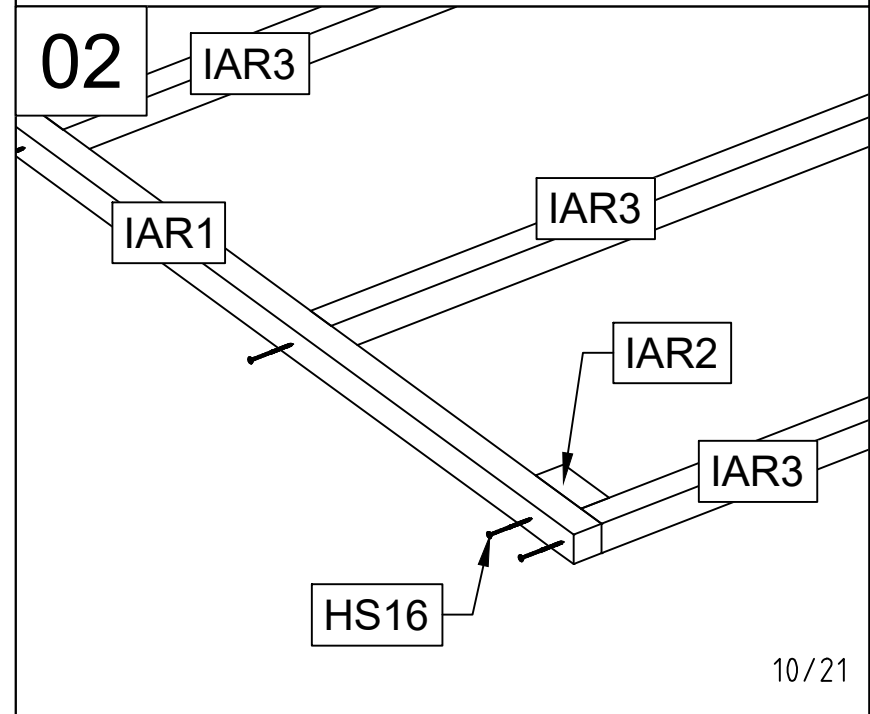
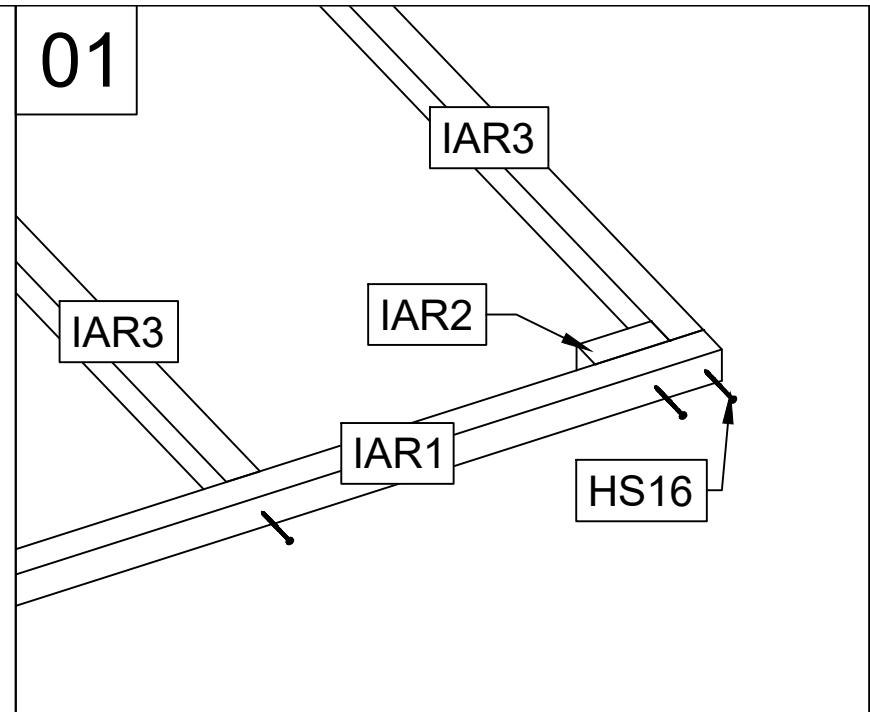
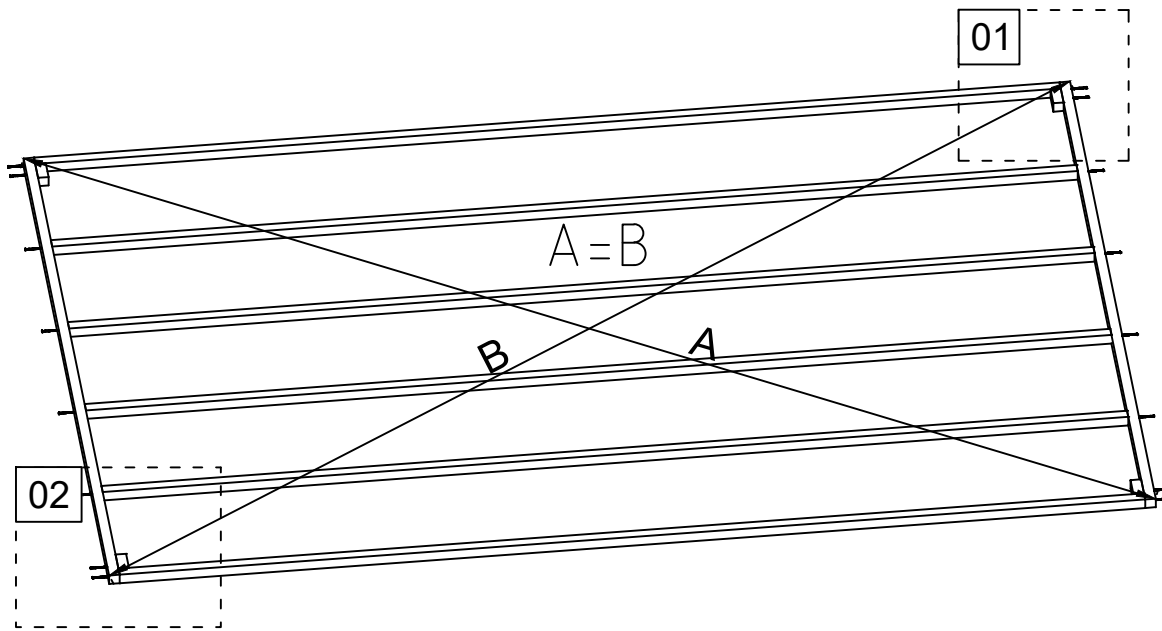

Art. Nr. 2853500

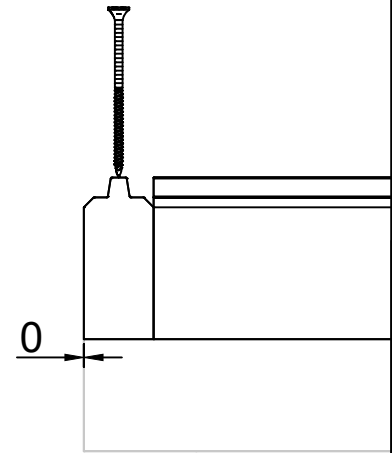
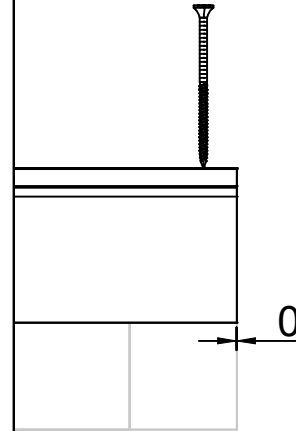
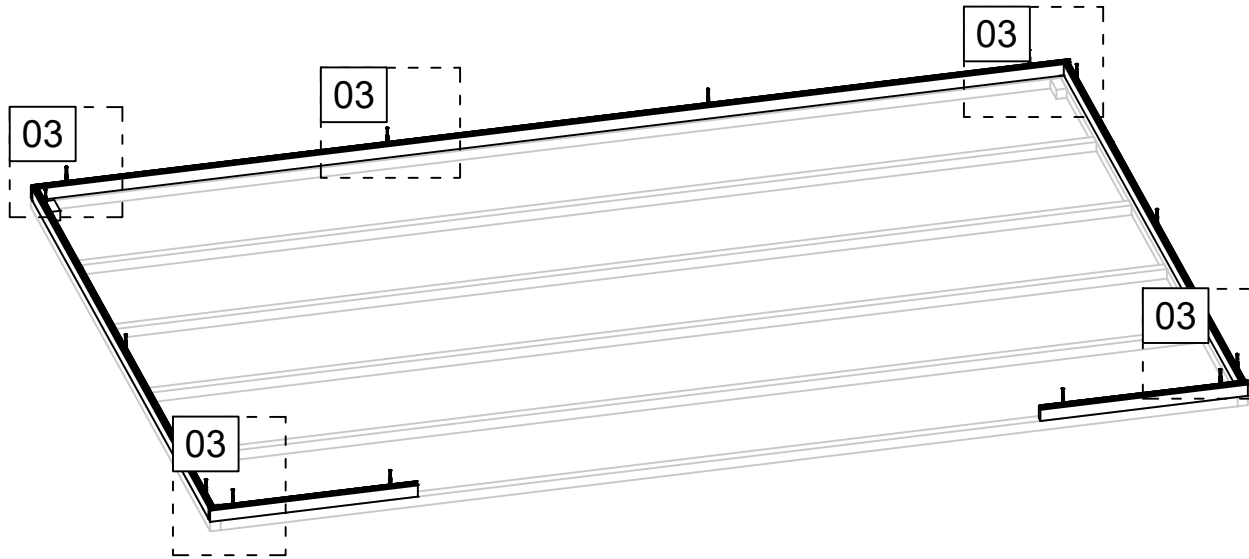

03

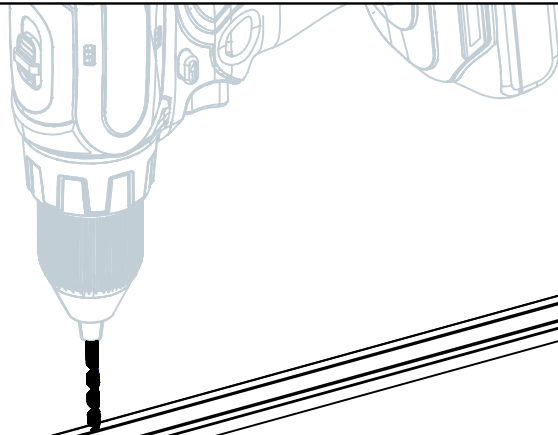

5 MM

03

HS16



Art. Nr. 2853500

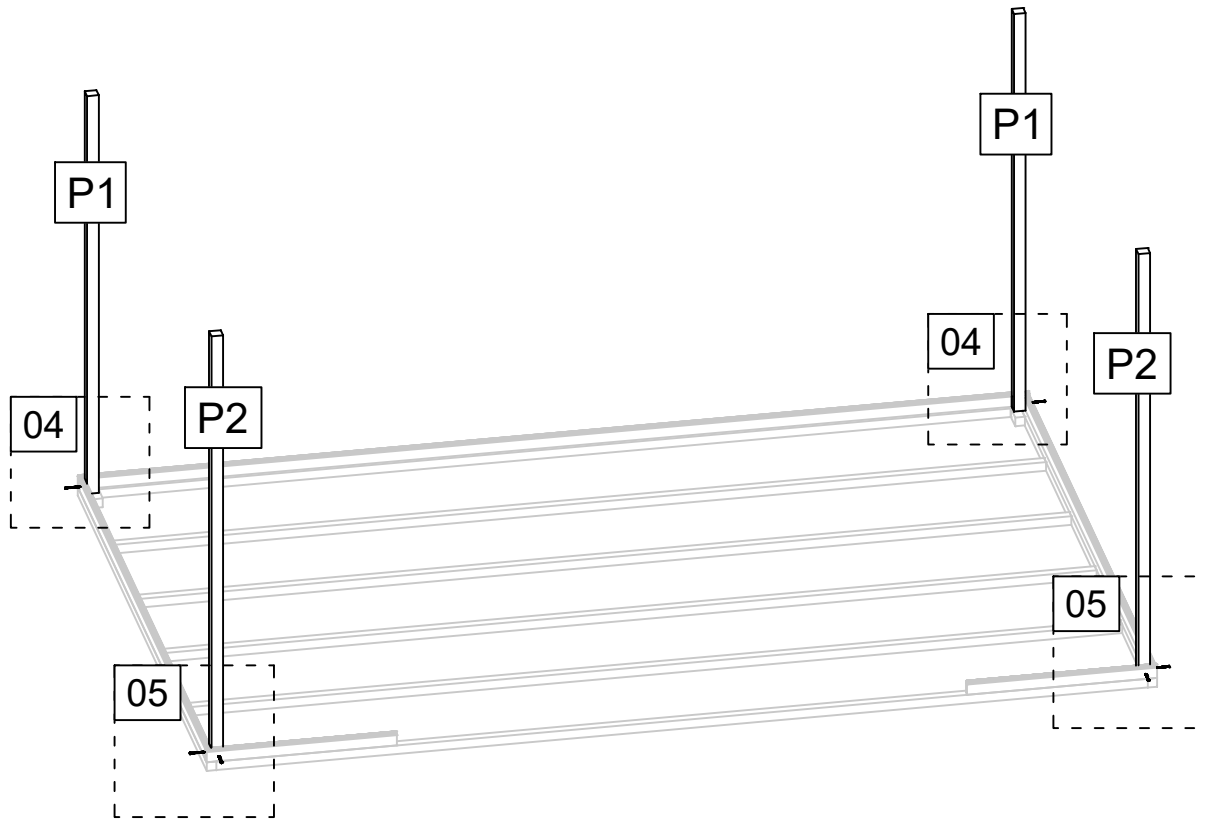

04

P1

HS13

≈5,5

≈5,5

05

P2

HS13

≈5,5

≈5,5

Art. Nr. 2853500

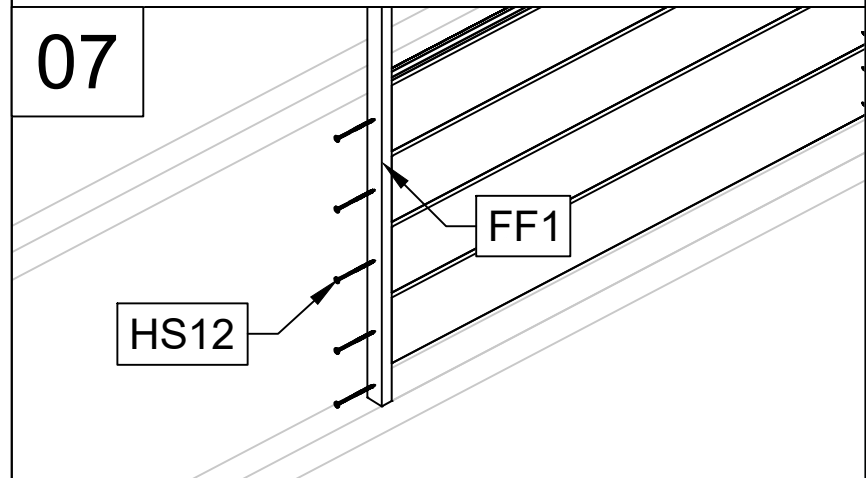
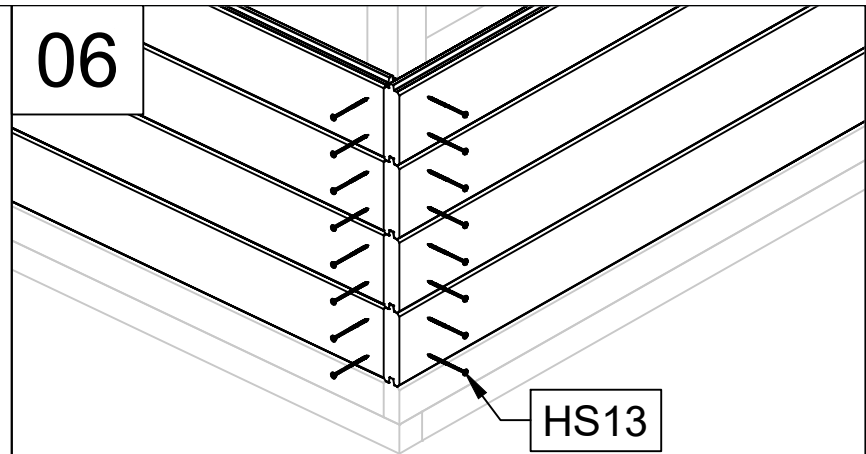
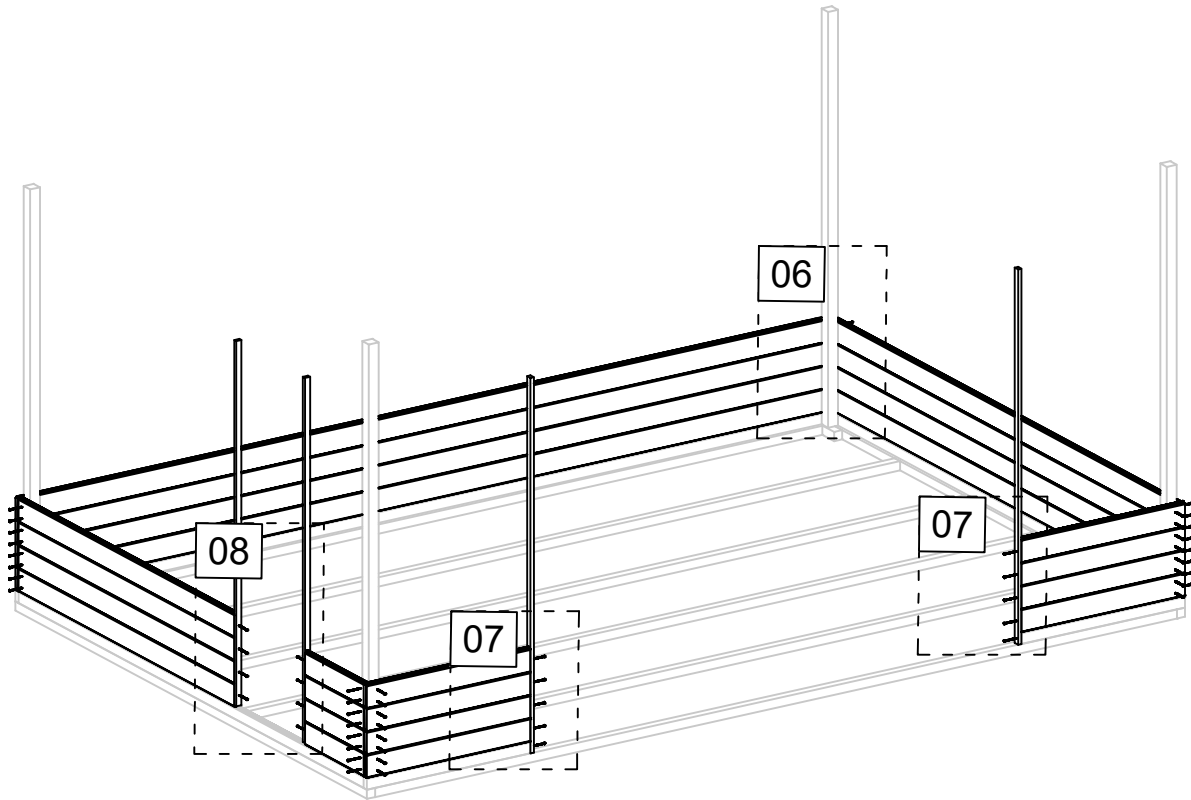

Art. Nr. 2853500

09

10

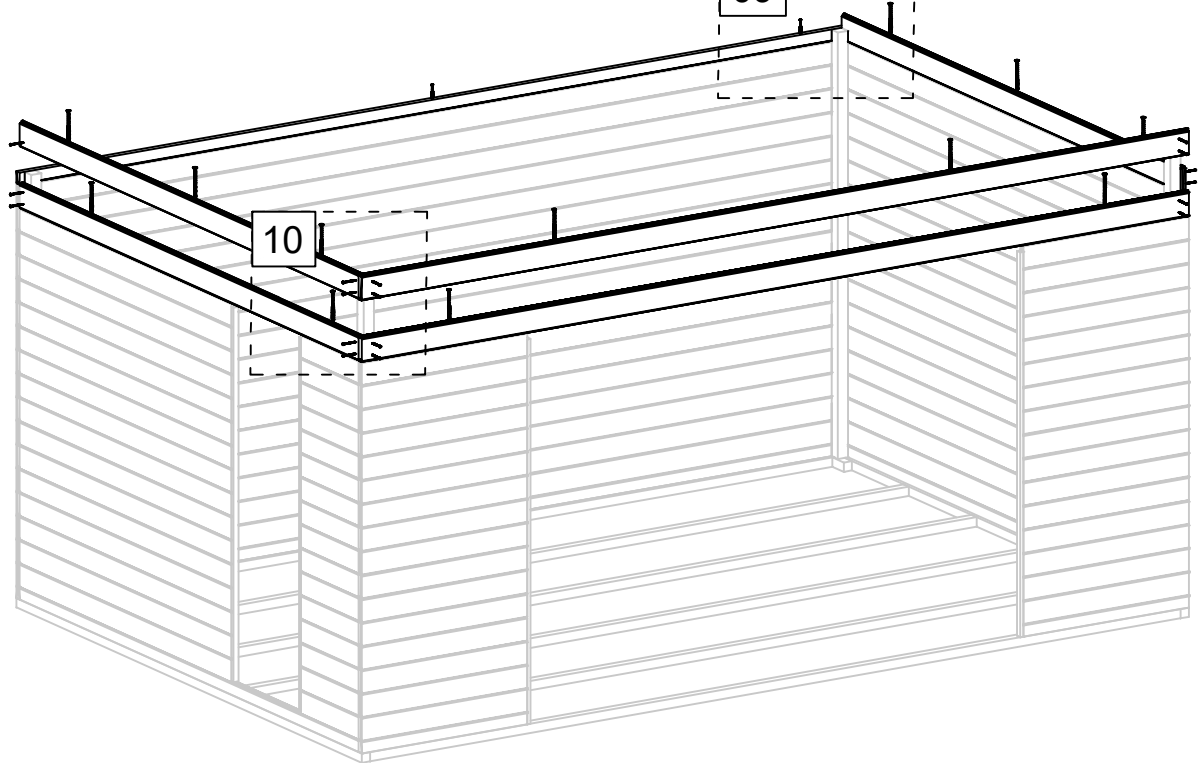

09

HS23

HS16

HS13

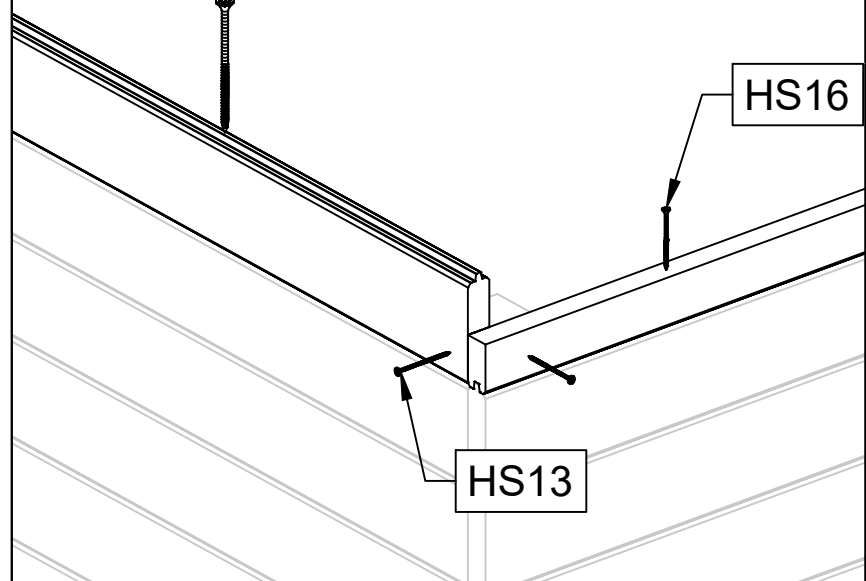

10

HS23

HS13

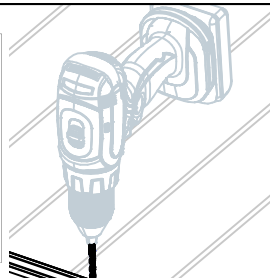
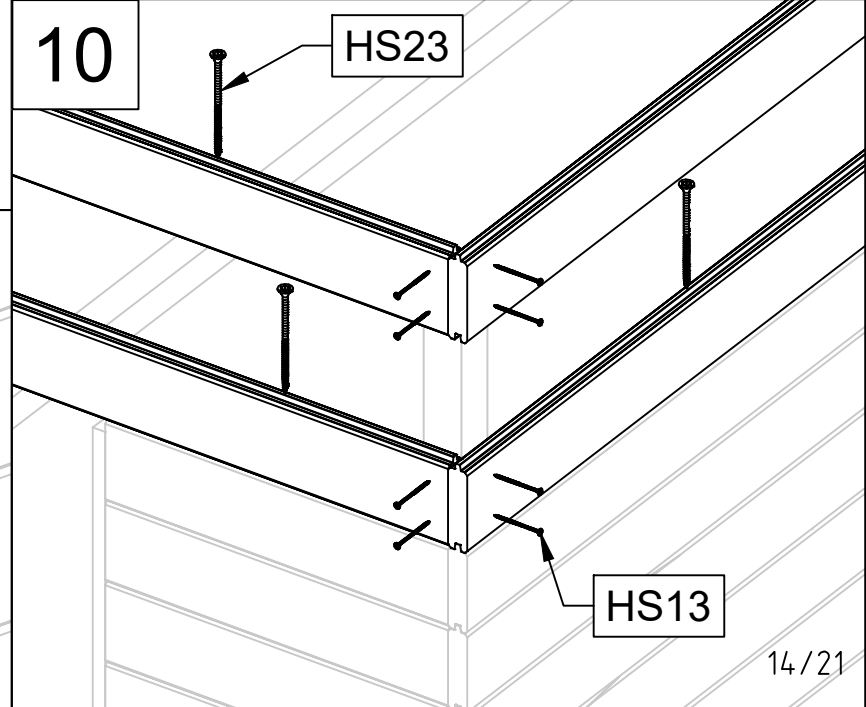

HS23

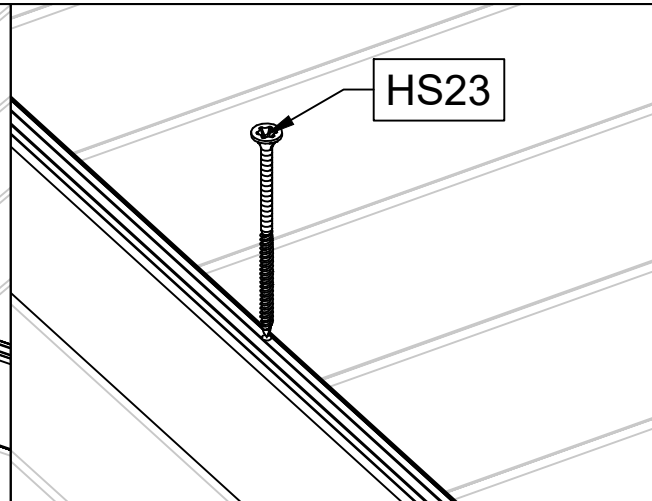

Art. Nr. 2853500

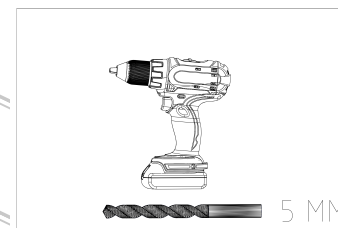
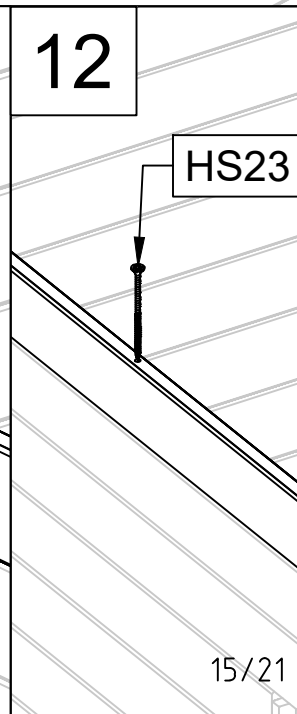
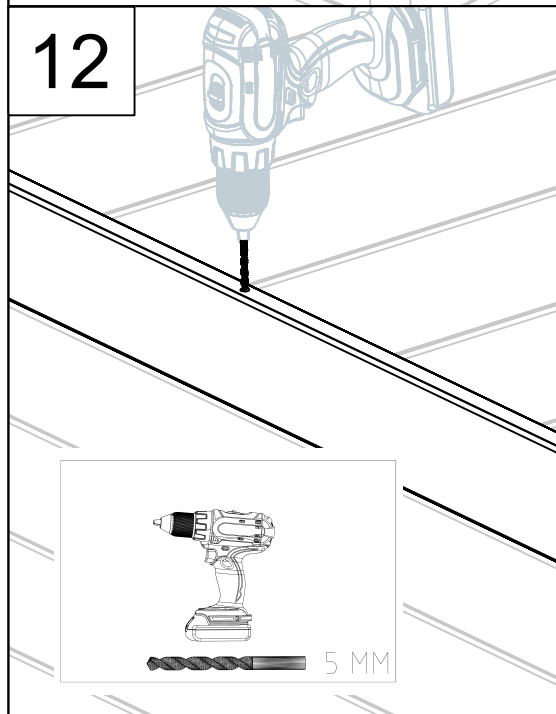
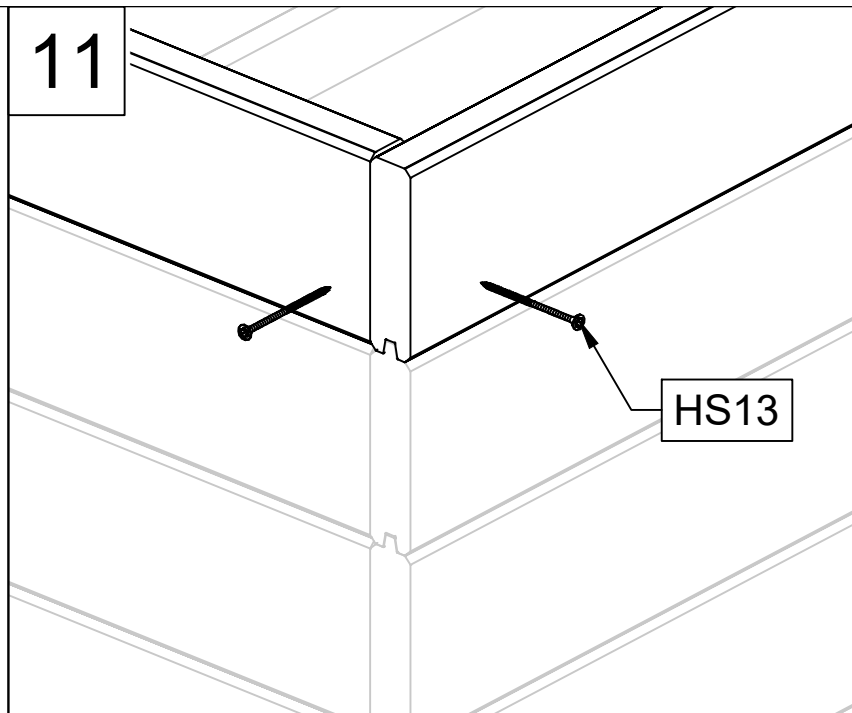
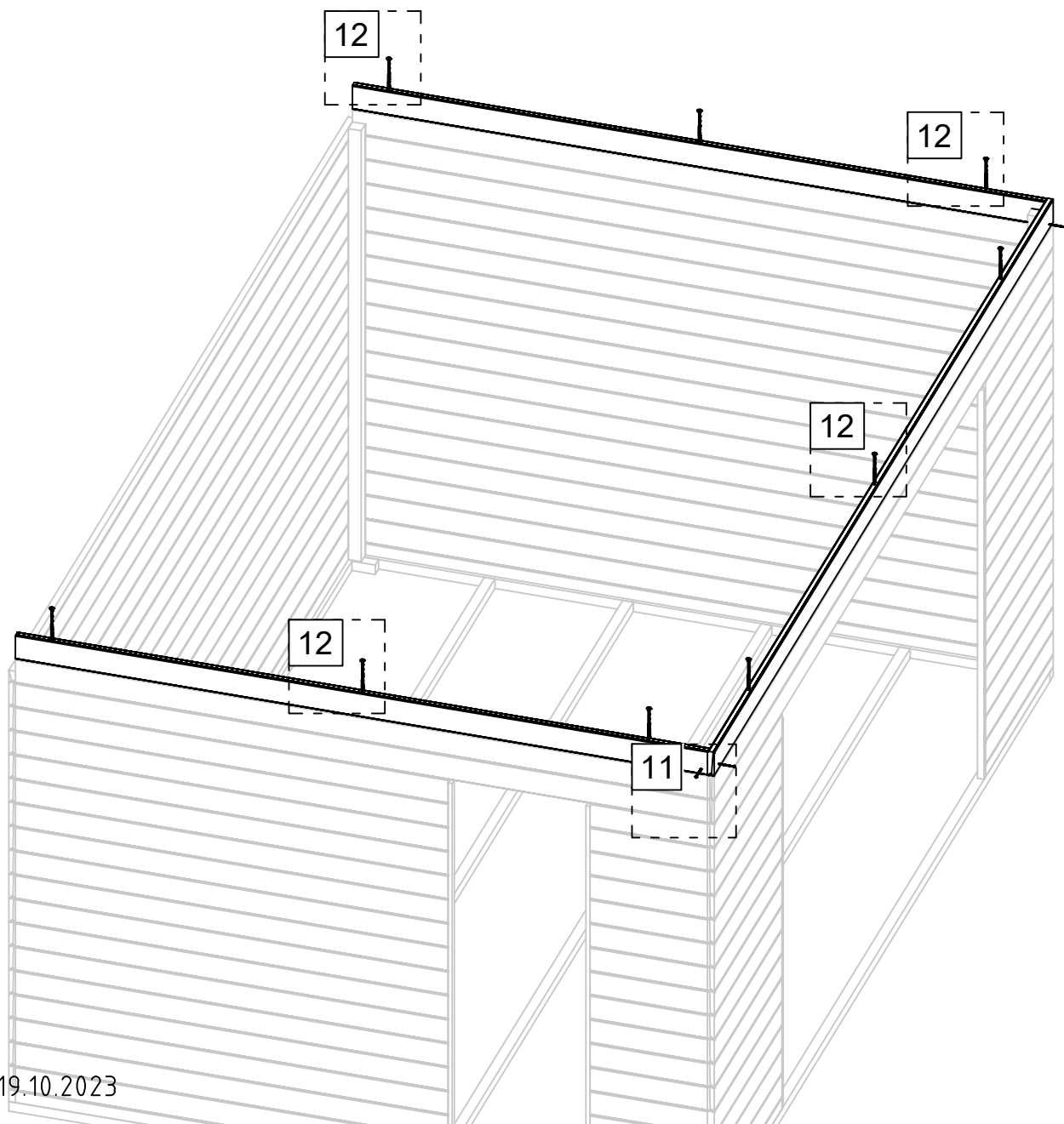

Art. Nr. 2853500

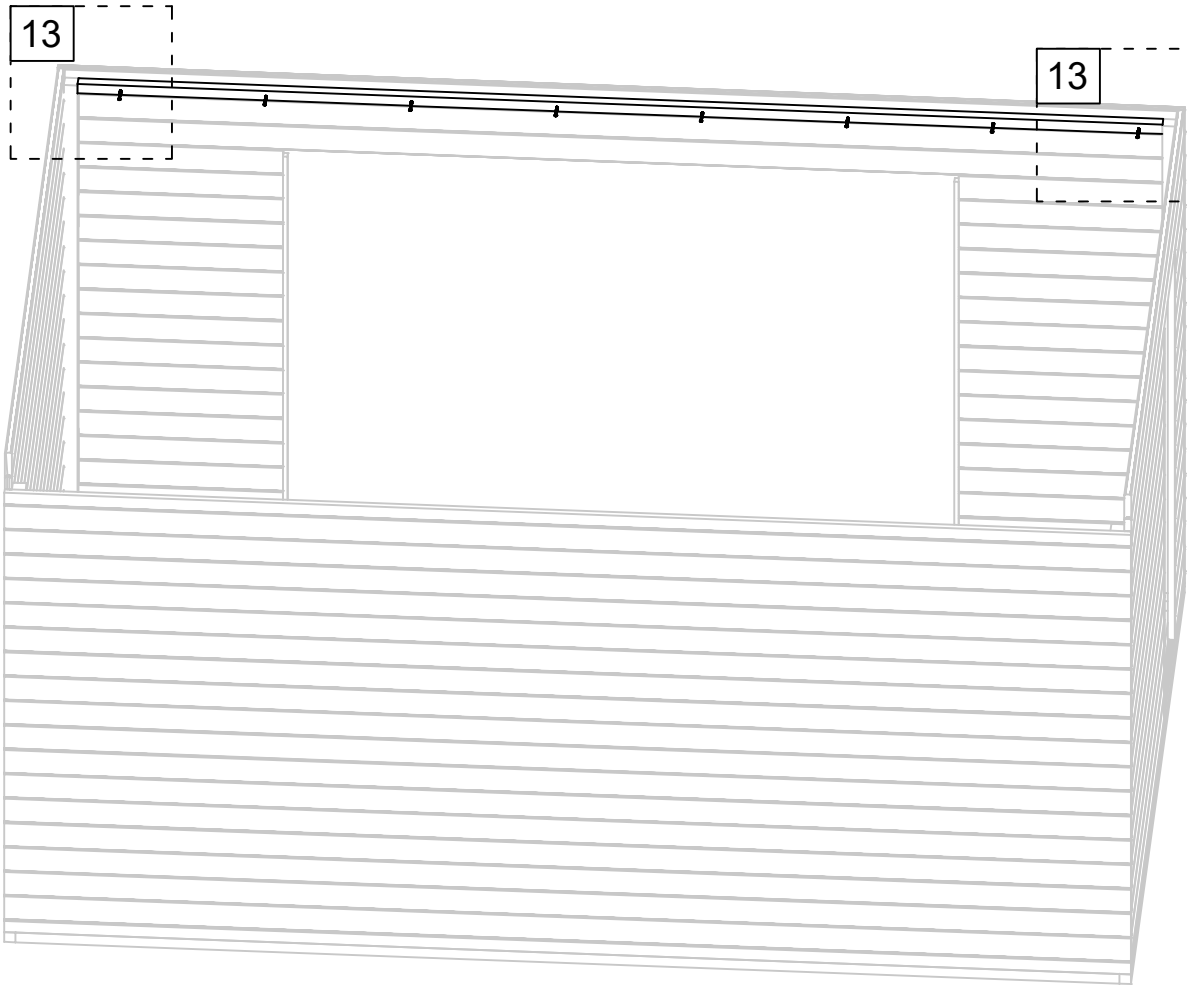

13

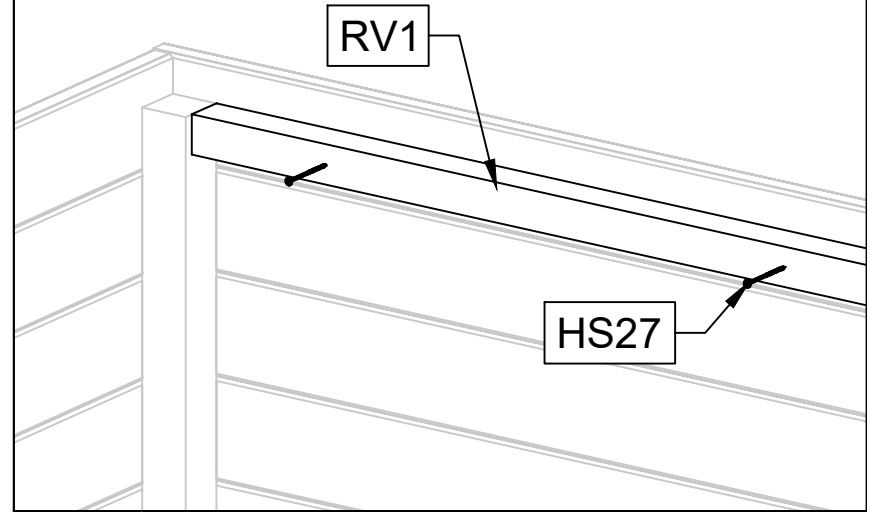

13

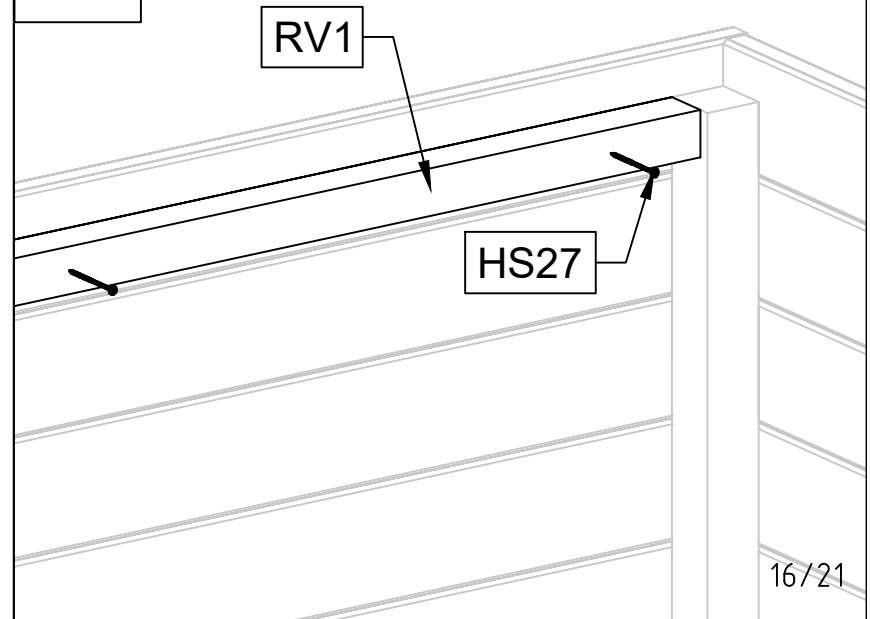

Art. Nr. 2853500

14

14

14

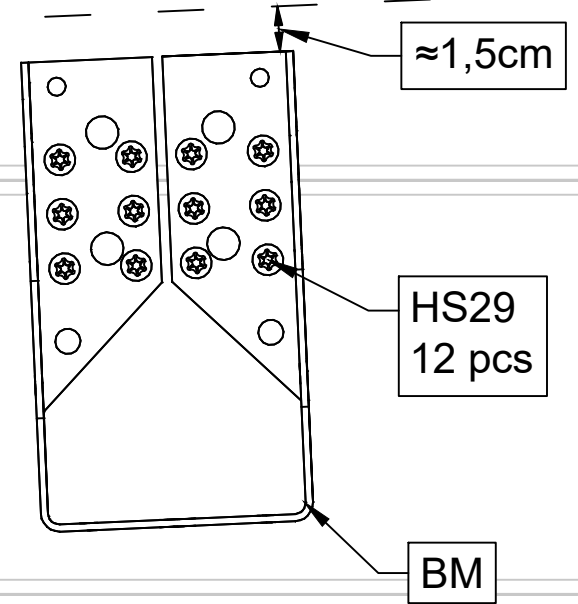

14

7

7

7

7

≈52,5

≈52,5

≈52,5

≈52,5

≈52,5

006

RV1

Art. Nr. 2853500

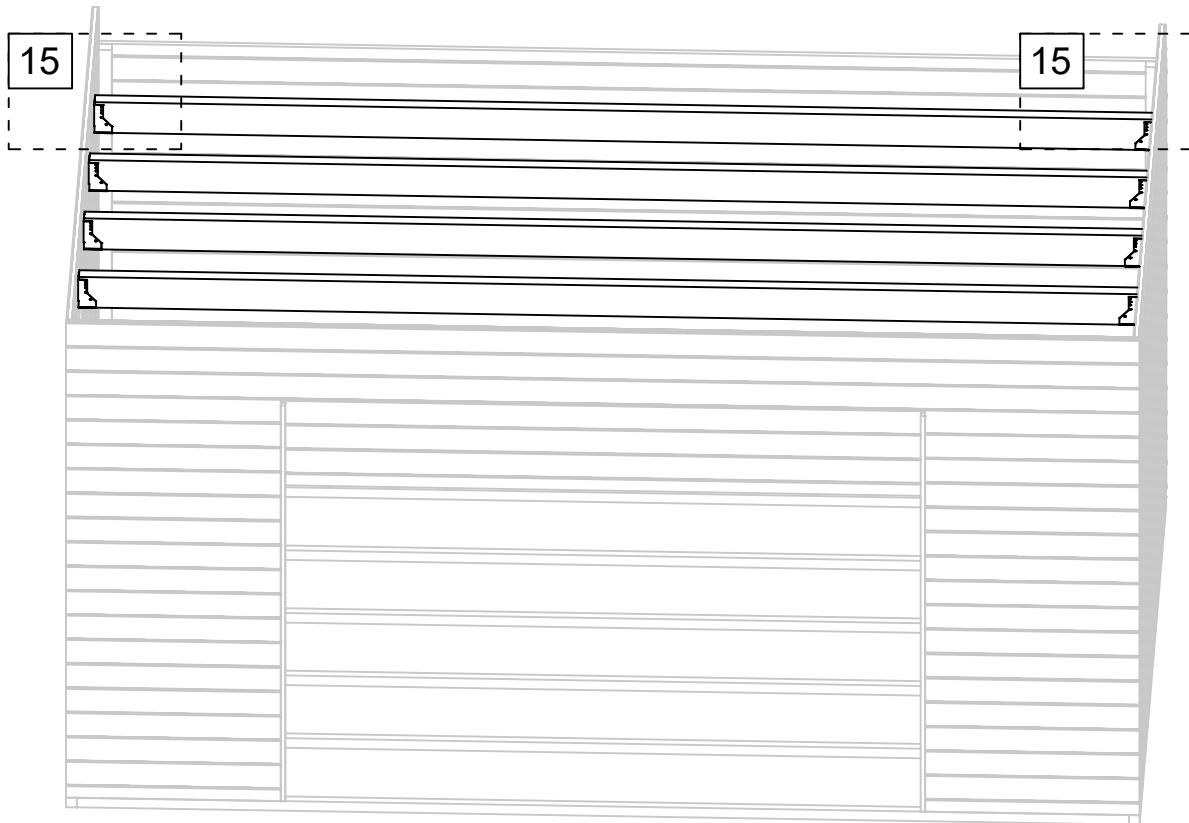

15

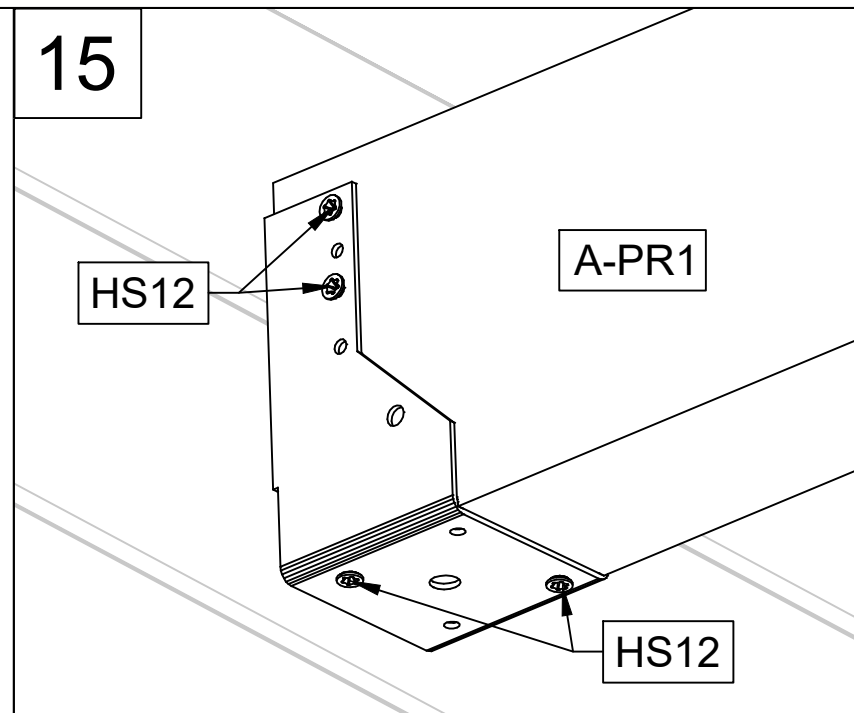

15

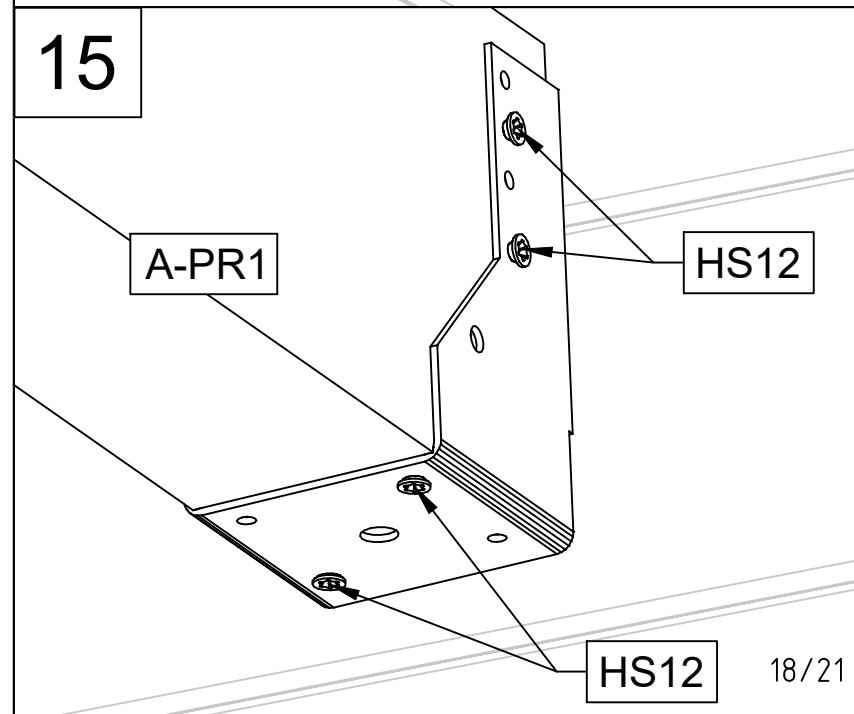

Art. Nr. 2853500

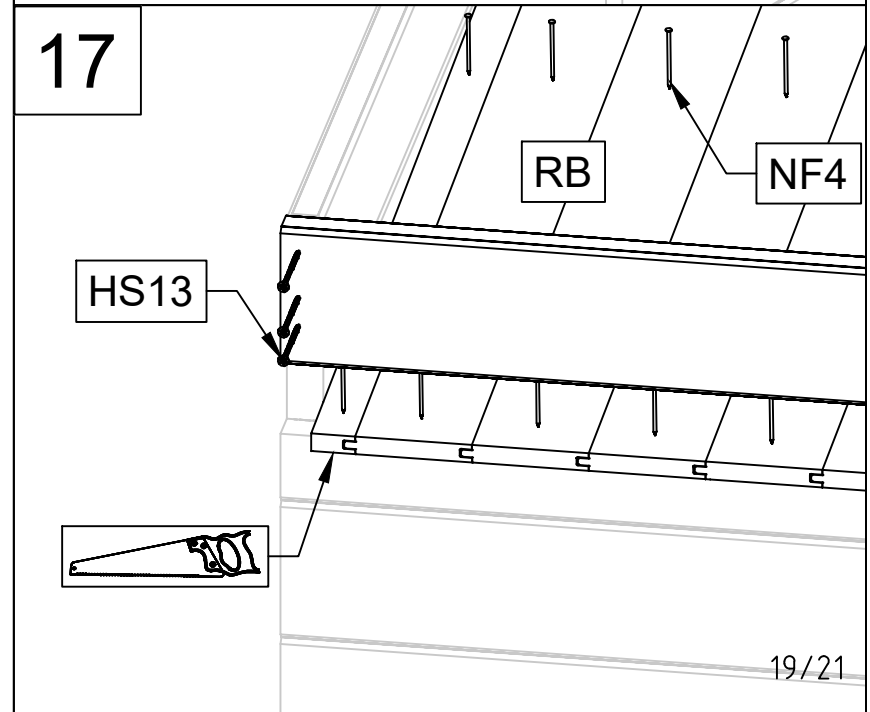
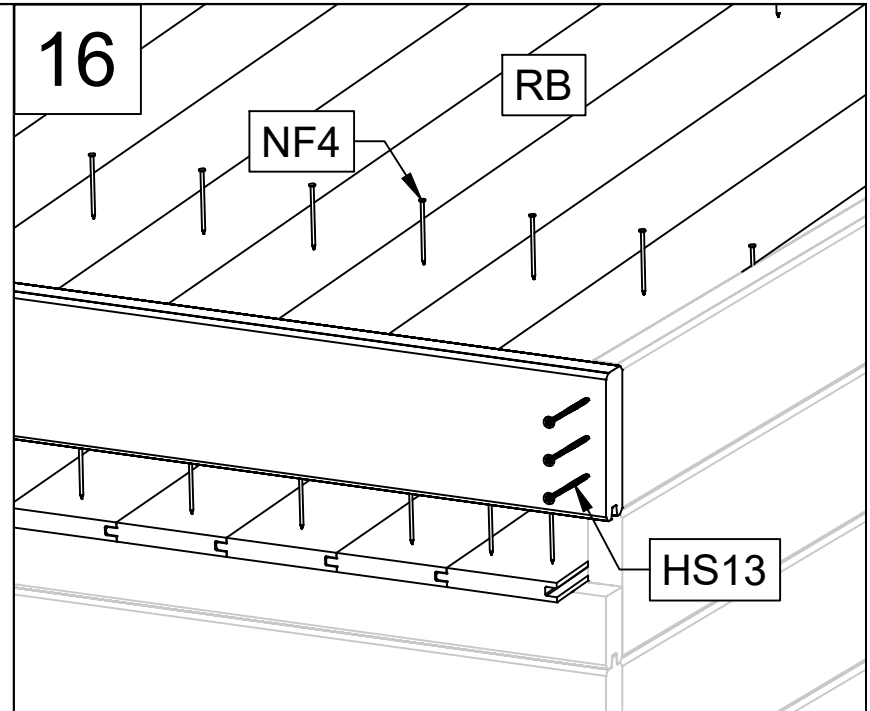
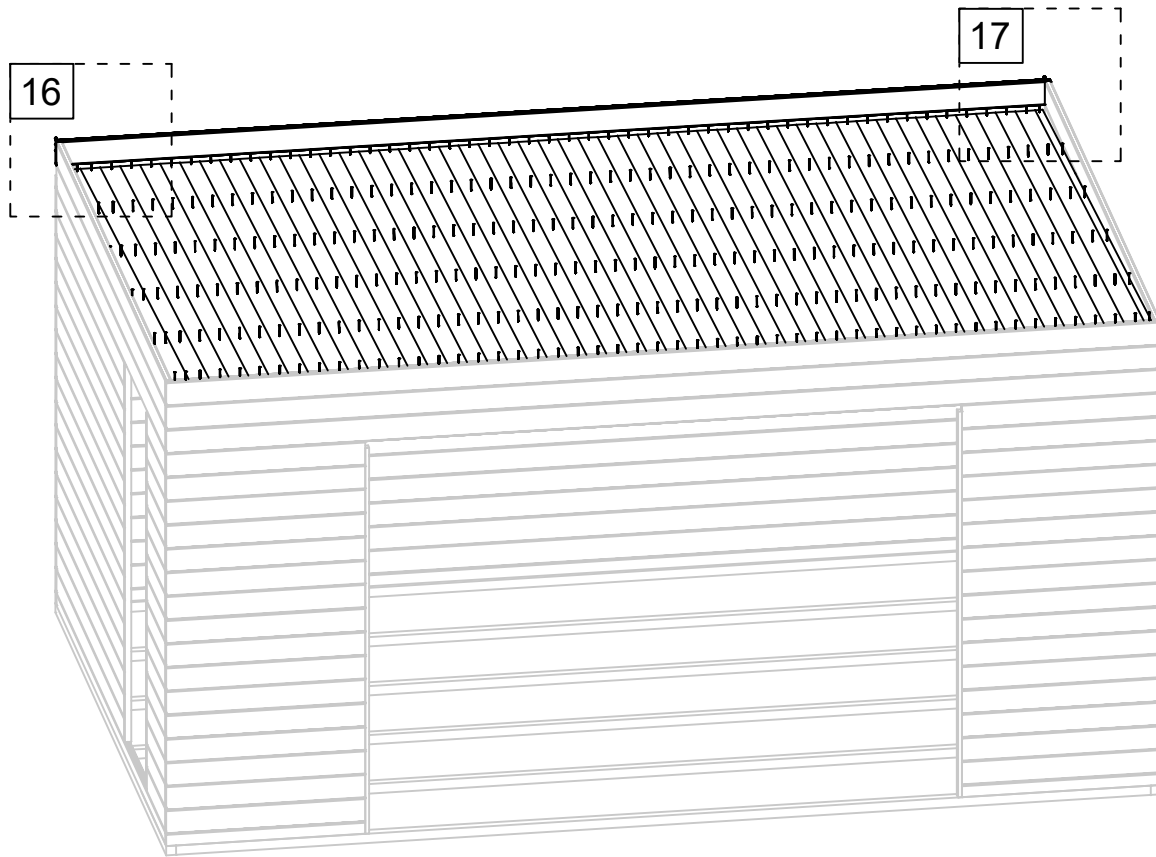

Art. Nr. 2853500

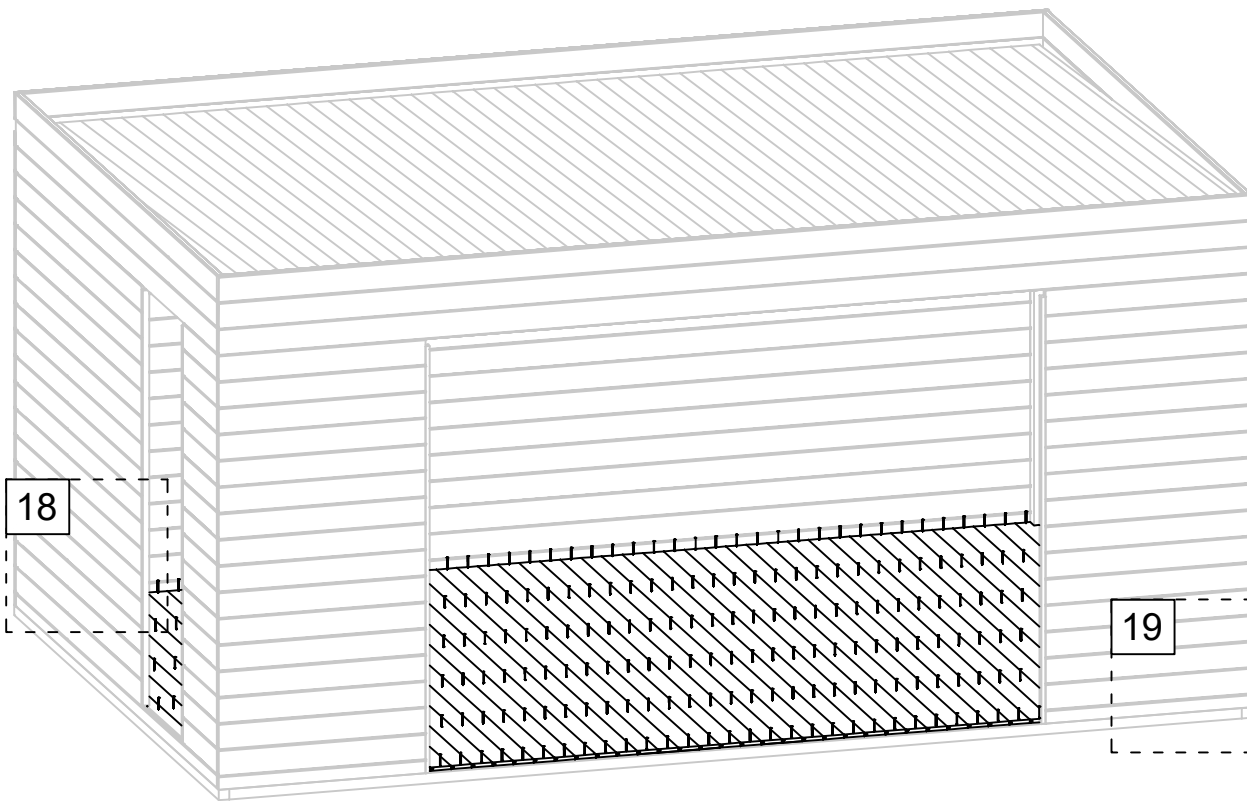

18

19

18

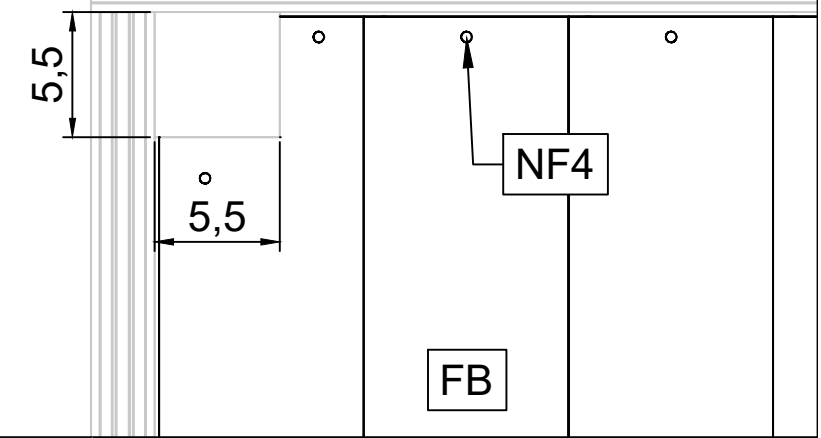
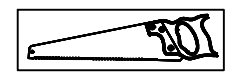



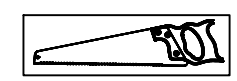
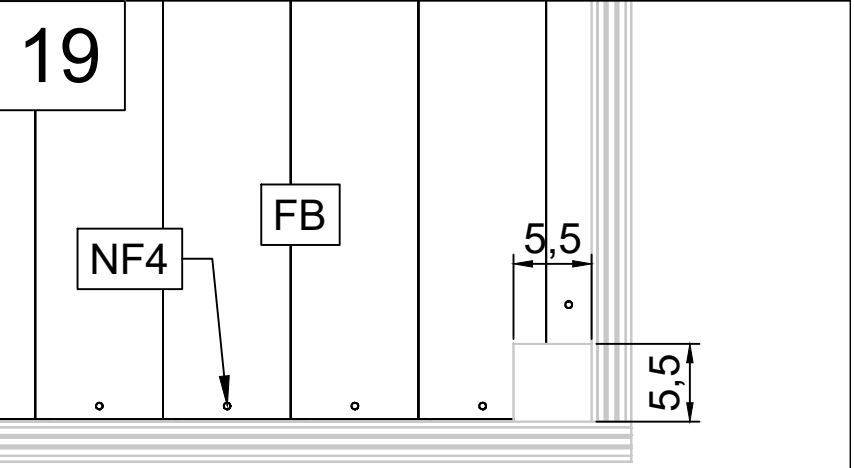

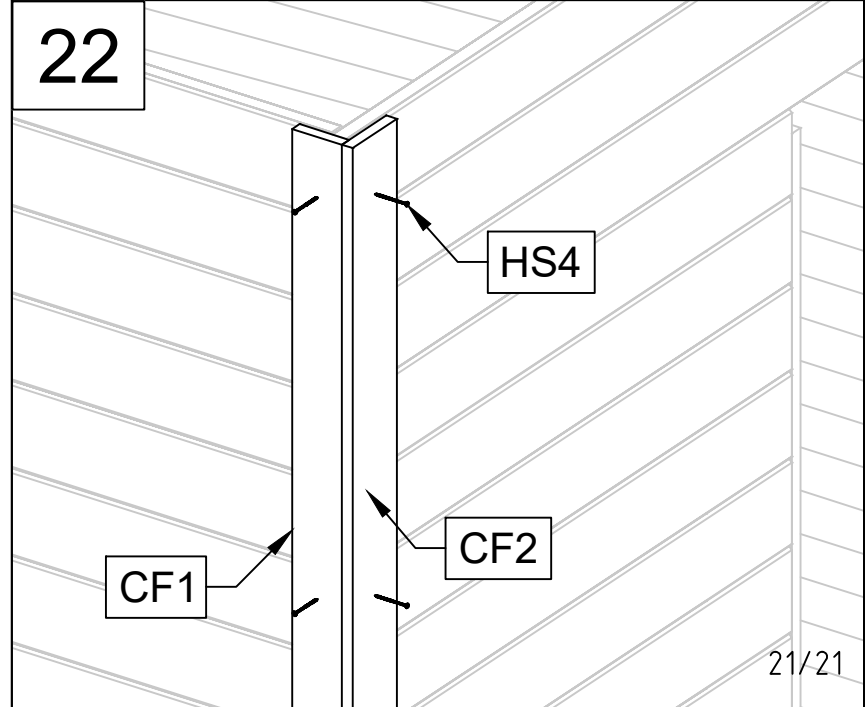
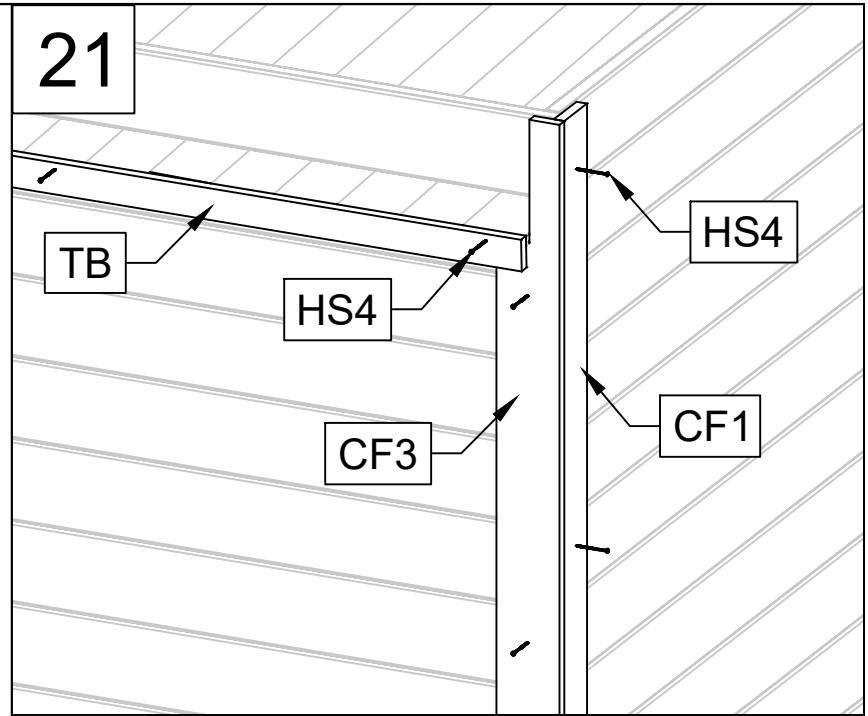
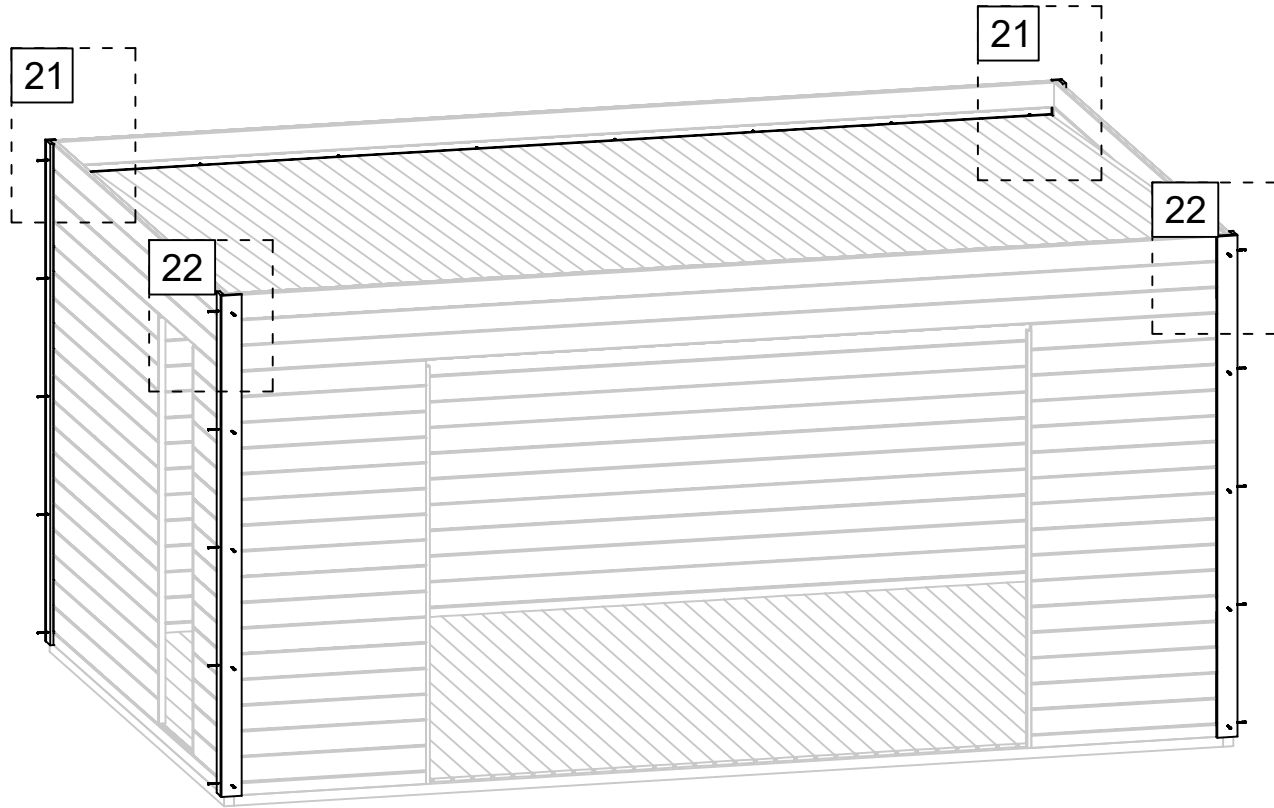

19

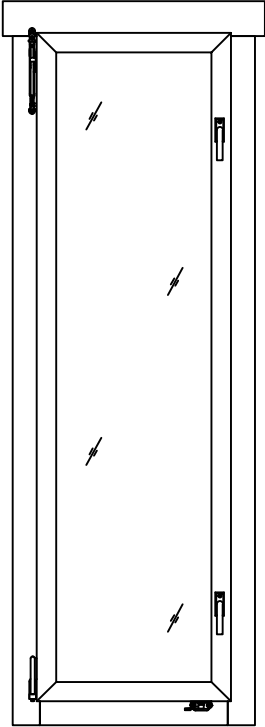
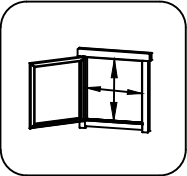
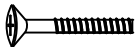

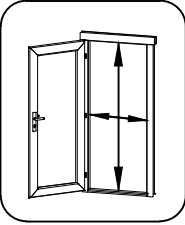
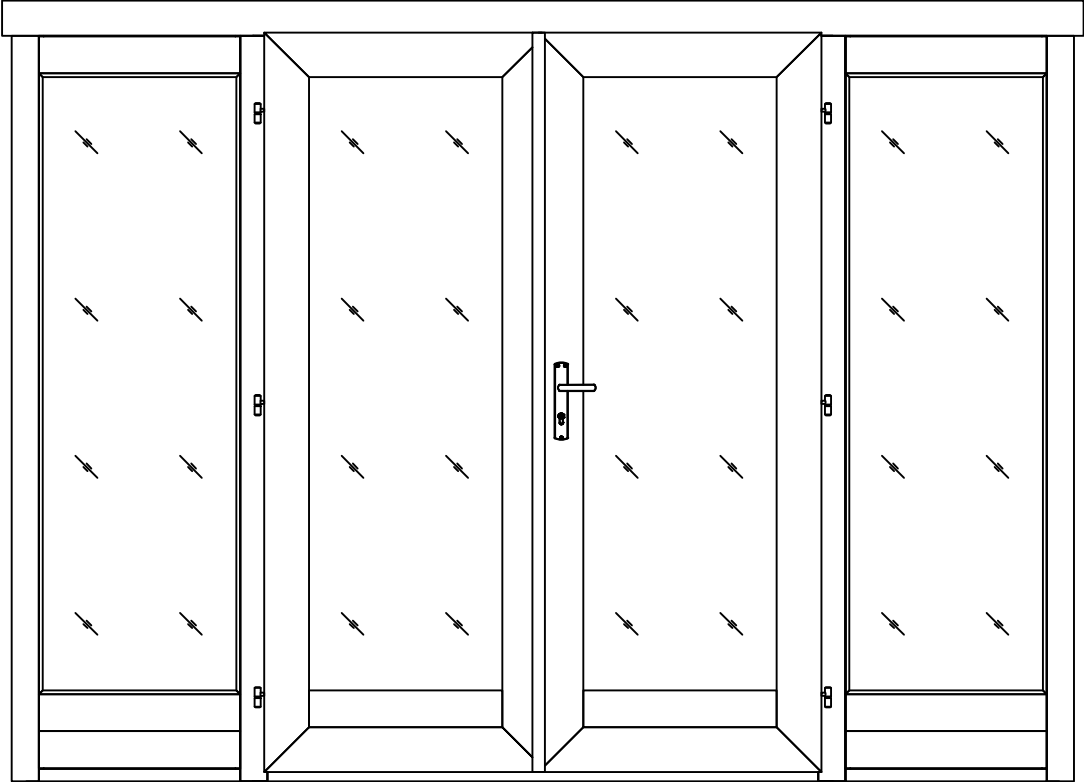
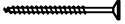
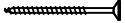
Art. Nr. 2853500

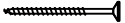

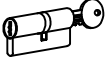
| Pos | 29.01.2016 Piece list - Stückliste - Liste des pièces - Elementi - Stuklijst - Tükitalabel 560x1780 AK.1.100.SSV SGC | 1/1 | Q | P (mm) | L (mm) |
|-----|--|---|---|-----------|-----------|
| | <p data-bbox="260 145 1289 174">Glass size - Glasgröße - Taille de la vitre - Misura del vetro - Glas afmeting - Klaasi mõõt: 416x1636 mm</p>   <p data-bbox="1364 342 1497 371">460x1680 mm</p> | | | | |
| FS1 | <p data-bbox="260 2040 1023 2096">Window handle fittings - Fenstergriff - Poignee de fenetre - Maniglia c/ferramenta - Raamhendel -/grendel -/klink - Aknalink</p> | | 2 | | |
| FSP | <p data-bbox="260 2119 1102 2197">Bolt for window handle fittings - Bolzen für fenstergriff beschlag - Vis pour fixation poignee de fenetre - Bullone x apertura manuale finestra - Schroef voor raamhendel - Akna käepideme polt</p> |  | 4 | | |

| Pos | 19.03.2022 | Piece list - Stückliste - Liste des pièces - Elementi - Stuklijst - Tükítabel 2658x1850 3UK.1.100.SVP.M SGC | 1/1 | Q | P (mm) | L (mm) |
|------|--|--|-----|--------|-----------|---|
| | | Glass size - Glasgröße - Taille de la vitre - Misura del vetro - Glas afmeting - Klaasi mõõt: 514x1487mm | | | | |
| | | | | | |  1394x1768 mm |
| | |  | | | | |
| HS9 | Screw for covering moulding - Schrauben für deckungsprofil - Vis de fixation profils horizontaux haut inférieur et extérieur d'encadrement de porte - Vite per cornice di copertura - Schroef voor afdekprofiel - Kruvi piirdelauale |  | 14 | 3.5x50 | | |
| HS4 | Screw for door fillet - Schraube zur befestigung türleiste - Vis pour fixation baguette d'arrêt de porte - Viti per massellino della porta - Schroef voor deurlijst - Kruvi ukse kokkuvältsiliistule |  | 5 | 3x30 | | |
| HS1 | Screw for door jamb - Schraube für türrahmen - Vis de fixation partie haute avec montants du cadre de porte - Viti x fissaggio montanti porte - Schroef voor deurkozijn - Kruvi ukse lengile |  | 6 | 5x90 | | |
| HS25 | Screw for doorstep - Schrauben für swelle - Vis pour fixation barre de seuil - Vite per soglia della porta - Schroef voor deurdorpel - Kruvi lävepakule |  | 3 | 4.5x65 | | |
| TL4 | Door handle fittings - Türgriff - Poignée de porte - Maniglie - Deurhendel / klink - Ukse käepide VU |  | 1 | | | |
| TL5 | Set of door lock covers - Schlossblenden - Set de garnitures de porte - Copertura serrature - Slot sluitplaat set - Ukse lukuplaat |  | 1 | | | |
| | Cylinder lock - Zylinderschloss - Barillet de porte - Serratura - Cylinder slot - Ukse lukusüdamik |  | 1 | 30x35 | | |
| | Striker for barrel bolt - Hülse für grendelriegel - Gache au sol du targette - Boccola per fermo della porta - Huls voor vergrendelingsschuif - Vasturaud ukse servariivile |  | 2 | | | |

